



**Power Electronic Measurements**

**ROGOWSKI CURRENT TRANSDUCERS**

**INSTRUCTIONS FOR USE**  
**RCTi and RCTi-3ph**

***POWER ELECTRONIC MEASUREMENTS Ltd.***

Gloucester House, Wellington Street, Long Eaton, Nottingham, NG10 4HT, U.K.

Tel: +44 115 946 9657

Fax: +44 115 946 8515

Email: [info@pemuk.com](mailto:info@pemuk.com)

[www.pemuk.com](http://www.pemuk.com)

Distributed By:

**GMW Associates**

955 Industrial Road, San Carlos, CA, 94070 USA

PHONE: +1 650-802-8292 FAX: +1 650-802-8298 EMAIL: [sales@gmw.com](mailto:sales@gmw.com) WEB: [www.gmw.com](http://www.gmw.com)

© Copyright 2005 -Power Electronic Measurements Ltd  
Issue date: May 2011

# **CONTENTS**

- 1. Introduction**
- 2. Technical Specification**
- 3. Standards and Approvals**
- 4. RCTi Rogowski Current Transducer – Overview**
- 5. RCTi-3ph Rogowski Current Transducer – Overview**
- 6. Safety and pre-use Checks**
- 7. Connections and Cabling**
- 8. Switching the Unit On**
- 9. Obtaining the Best Measurement**
- 10. Cleaning and Decontamination**
- 11. Warranty**
- 12. Returning RCTi for Recalibration or Repair**

## 1. INTRODUCTION

The RCT*i* is a wide-bandwidth, flexible, clip-around current transducer for measuring ac currents.

PEM's Rogowski Current Waveform Transducers combine high bandwidth, safety, and the minimum disruption to the circuit under test. These instructions should be followed whenever the unit is used. They are intended to help you obtain the best and safest performance from the transducer.

## 2. TECHNICAL SPECIFICATION

The RCT*i* has the following specification:

<b>Rated Current (I<sub>p</sub>)</b>	Refer to ID Label
<b>Rated Output</b>	5V <sub>rms</sub> (±7.07V peak) (FS)
<b>Output limit</b>	150% FS
<b>Output load</b>	>10kΩ for rated accuracy
<b>Bandwidth (-3dB)</b>	<b>for I<sub>p</sub> &lt; 2000A</b> 0.6Hz to 1MHz (300mm coil) [600kHz (700mm coil)] <b>for I<sub>p</sub> ≥ 2000A</b> 0.2Hz to 1MHz (300mm coil) [600kHz (700mm coil)]
<b>Operating temperature range</b>	-5°C to +65°C ( <i>Integrator electronics</i> ) -20°C to +80°C ( <i>Coil and cable</i> )
<b>Accuracy (typ.)</b>	±1.0% of reading (5% to 150% FS, 25°C)
<b>Supply voltage</b>	12Vdc (-10%) <i>-to-</i> 24Vdc (+20%)
<b>Supply power</b>	0.4W (max.) RCT <i>i</i> <i>-and-</i> 1.2W (max.) RCT <i>i</i> -3ph
<b>Supply isolation</b>	2.0kV dc
<b>Coil insulation</b>	2.0kV peak
<b>Environmental</b>	Indoor use / Altitude up to 2000m Installation Category III, Pollution Degree 2.

## 3. STANDARDS AND APPROVALS

<b>EMC approvals</b>	EN61326-1:2006
<b>Safety approvals</b>	EN61010-1:2001 Safety requirements for electrical equipment for measurement, control and laboratory use
<b>Quality system</b>	ISO9001:2008 third party audited

## 4. OVERVIEW: RCT $i$ – ROGOWSKI CURRENT TRANSDUCER

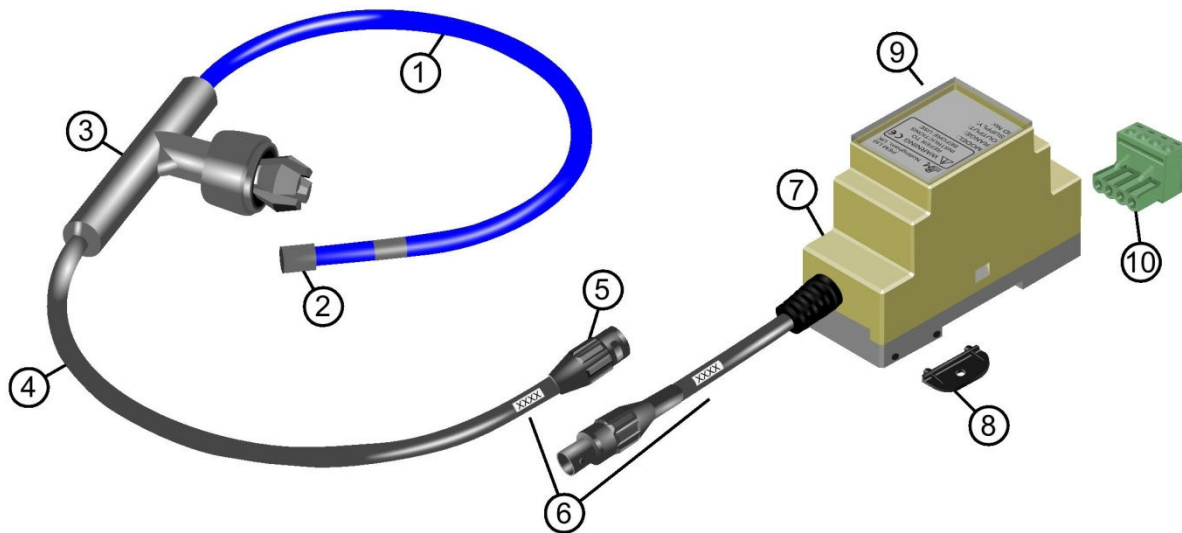

1. **Rogowski coil** (loop).
2. **'Free-end'** of the Rogowski coil
3. **Ferrule** (the connecting mechanism for closing the Rogowski coil).
4. **Cable connecting the Rogowski coil to the integrator** - doubly screened low noise co-axial cable.  
 *The Rogowski coil and connecting cable have double or re-enforced insulation.*
5. **OPTION - BNC:BNC split in the cable** between the Rogowski coil and electronic integrator
6. **Coil / cable identification label on both BNC connector and enclosure**  
4 digit number XXXX
7. **Plastic DIN rail mount electronic enclosure** housing the electronic integrator.  
*For mounting on DIN RAIL according to DIN EN 50 022*
8. **Position for removable tabs to enable panel mounting of the enclosure.**  
*Mounting screw size is M4 (not supplied)*
9. **Identification label** providing
  - Serial number
  - Rated primary current  $I_p$
  - Rated output  $V_s$
  - Supply voltage
10. **Removable screw terminal connector plug for the SUPPLY and LOAD connections**

## 5. OVERVIEW: RCTi-3ph – ROGOWSKI CURRENT TRANSDUCER

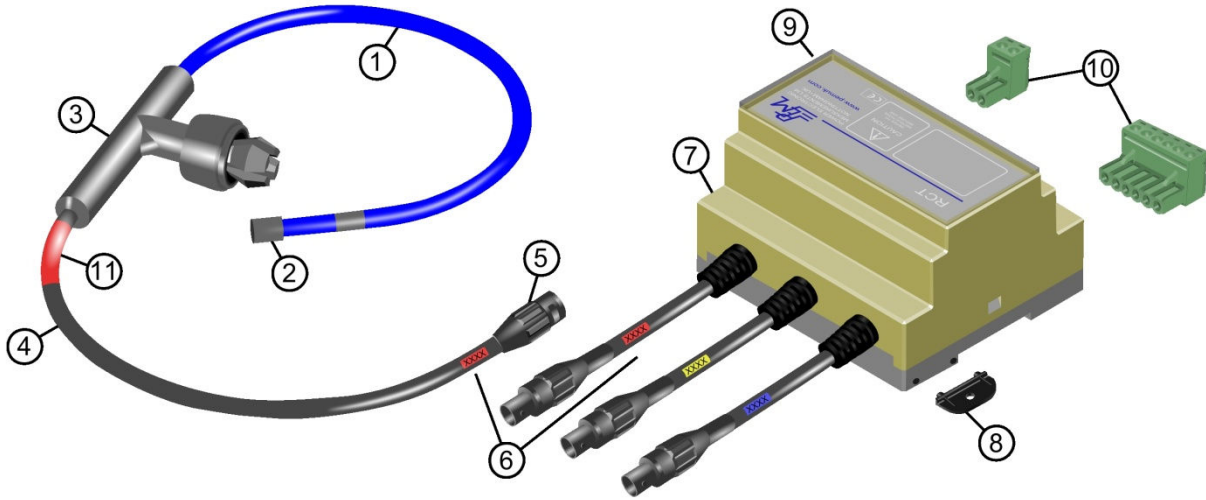

1. **Rogowski coil** (loop).
2. **'Free-end'** of the Rogowski coil
3. **Ferrule** (the connecting mechanism for closing the Rogowski coil).
4. **Cable connecting the Rogowski coil to the integrator** - doubly screened low noise co-axial cable.  
 *The Rogowski coil and connecting cable have double or re-enforced insulation.*
5. **OPTION - BNC:BNC split in the cable** between the Rogowski coil and electronic integrator
6. **Coil / cable identification label on both BNC connector and enclosure**  
4 digit number XXXX – colour coded see 11.
7. **Plastic DIN rail mount electronic enclosure** housing the electronic integrator.  
*For mounting on DIN RAIL according to DIN EN 50 022*
8. **Position for removable tabs to enable panel mounting of the enclosure.**  
*Mounting screw size is M4 (not supplied)*
9. **Identification label** providing
  - Serial number
  - Rated primary current  $I_p$
  - Rated output  $V_s$
  - Supply voltage
10. **Removable screw terminal connector plug for the SUPPLY and LOAD connections**
11. **Colour ident to identify the Rogowski coil to the correct output.**

## 6. SAFETY AND PRE-USE CHECKS

Throughout this instruction sheet there are a number of warnings which must be observed to ensure safe operation of this unit. These warnings are identified by the following symbol:



PEM accepts no responsibility for any accidents or damage resulting from careless use, or non-observance of these instructions.

### THE ROGOWSKI COIL



The integrity of the insulation around the Rogowski coil itself should be VISUALLY INSPECTED before use, and the unit should NOT BE USED if there are signs of damage.



When bending the flexible coil around a conductor, avoid tight bends and sharp edges that could damage the coil.



The voltage rating (safe PEAK working voltage) is clearly labelled on the coil. The rating is 2kV peak. The removable silicone sleeve supplied with the coil provides additional mechanical protection only.

The rating is derived from the following standard test: All coils supplied by PEM including the ferrule connecting the coil to the cable are flash tested for 1 minute at 4kVrms using a 50Hz sinewave.



For permanent installation the coil should be situated such that corona, which would eventually damage the coil insulation, cannot occur. For information regarding permanent installation of PEM's Rogowski coils on higher voltage equipment please consult PEM.



Voltage ratings are only valid if the 'free-end' of the coil is fully inserted into the socket, and remains fully inserted during use.

The 'free-end' will be fully inserted when the user feels the free-end of the coil engage with the internal click-in mechanism inside the ferrule.

Visual indication that the coil mechanism is fully inserted is provided by the black cable marker situated near the end of the coil, as shown overpage:

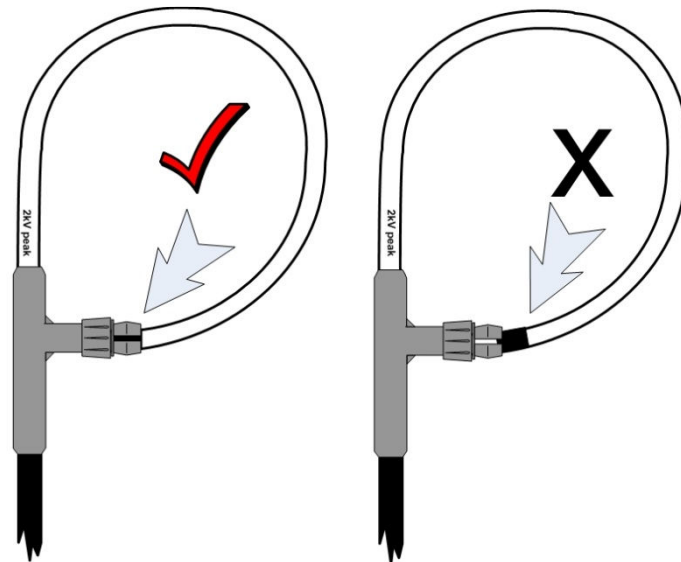

If the coil is to be left in-situ for any period of time or is used in an environment where the coil is subject to vibration the locking nut should be engaged as shown in the diagram below.

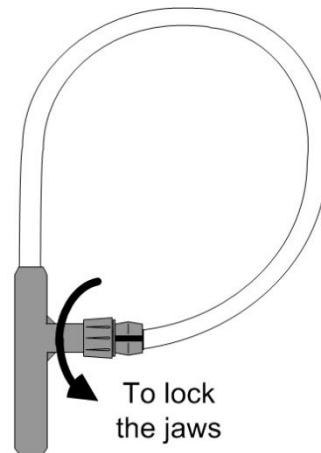

The locking mechanism must not be actuated at temperatures below 0°C

Care must be taken not to over-tighten the locking nut.

## THE CABLE FROM COIL TO INTEGRATOR



The optional BNC:BNC cable split is manufactured with touch protected isolated BNC connectors. The two halves of the BNC cable split should be connected before the conductor under test (primary current) is energised.

## THE INTEGRATOR



Terminal S2 should be connected to a LOAD which is connected to a safety earth.

## 7. CONNECTIONS AND CABLING

### RCTi

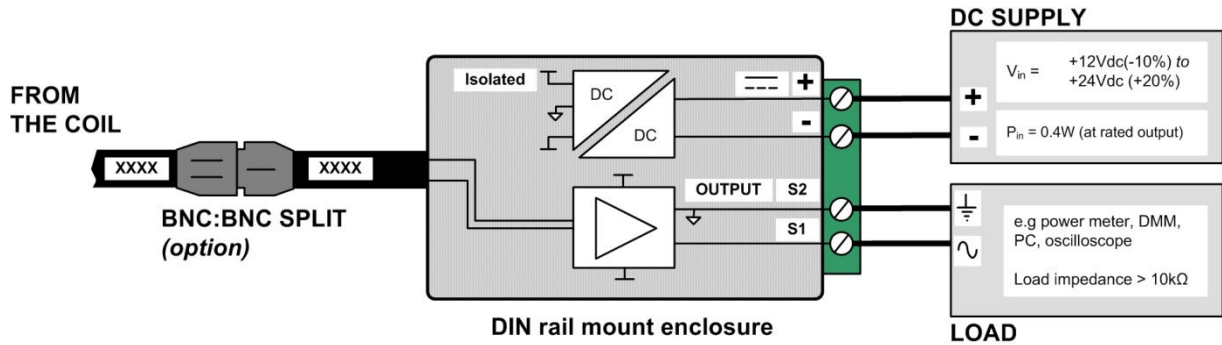

### RCTi-3ph

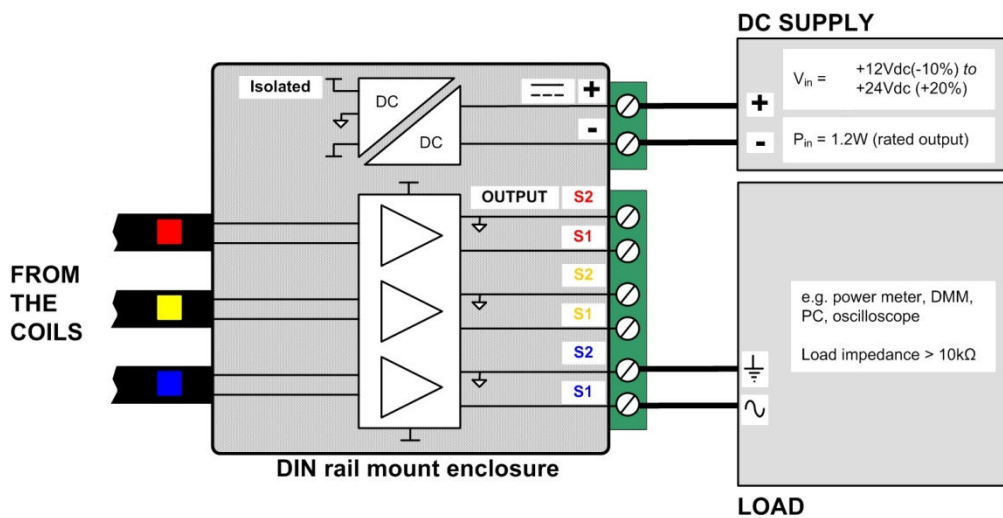

### BNC:BNC SPLIT

Where the OPTIONAL BNC CONNECTOR is supplied check that the correct coil is connected to the integrator. The cable from both the coil and the integrator should have the same four digit ID label XXXX close to the BNC connection.

The integrator is calibrated for a given coil and the correct coil must be used to ensure rated accuracy. The coils and integrator must not be swapped.

### DC SUPPLY

Explanation of symbols identifying the SUPPLY connections

- === Direct current
- + / - Positive / Negative terminal

The user must power the RCT with a suitable external DC power supply which should have the CE mark if the customer requires this certification.



The cable connecting the RCTi to the DC supply should be dual-core or twisted pair power cable of sufficient rating. The power supply cable should be connected to the rising clamp screw terminals:

- a. Max / min wire size: 4.0 mm<sup>2</sup> / 0.5 mm<sup>2</sup>
- b. Rated torque / screw size: 0.5 Nm / M3

In some electrically noisy environments it is best practice to use a shielded twin core power cable. In such cases the shield should be connected to the ground of the external dc power supply and left open circuit at the end connected to the RCTi.

## LOAD

Explanation of symbols identifying the LOAD connections

- (S1) Output signal
- (S2) Output signal

The cable connecting the RCTi to the LOAD should be dual-core or twisted pair power cable of less than 5m and of sufficient rating. The load cable should be connected to the rising clamp screw terminals:

- a. Max / min wire size: 4.0 mm<sup>2</sup> / 0.5 mm<sup>2</sup>
- b. Rated torque / screw size: 0.5 Nm / M3

In some electrically noisy environments it is best practice to use a shielded or doubly shielded cable. In such cases the outer shield should be connected to the ground of the load measuring device and left open circuit at the end connected to the RCTi.

## 8. SWITCHING THE UNIT ON

1. Mount the electronic enclosure housing the electronic integrator on a suitable DIN rail. Alternatively fit the two removable panel mount tabs to the enclosure and mount to a suitable panel. In both cases ensure that there is access to the removable PCB mount terminal block.



**Before switching the RCTi on** and taking a measurement the SAFETY AND PRE-USE CHECKS MUST BE FOLLOWED to ensure safe operation of your RCTi



**Before switching the RCTi on** refer to the CONNECTIONS AND CABLING section

2. The transducer is switched ON by supplying the correct DC SUPPLY to the RCTi. The DC supply voltage is clearly shown on the identification label on the electronic enclosure and is fully specified in '2. TECHNICAL SPECIFICATION' on page 3 of this manual.
3. After switch-on the RCTi requires a settling down time to attain its quiescent state before providing correct current measurement. The time, which depends on warm-up and low frequency bandwidth, can be as long as 2 minutes.
4. Having carried out the visual inspection of the Rogowski coil, un-clip the Rogowski coil.
5. Wrap the Rogowski coil around the de-energised conductor under test and fully insert the free-end of the Rogowski coil into the ferrule as shown in 6. SAFETY AND PRE-USE CHECKS.
6. The user is now ready to re-energise the conductor under test and take measurements.

## 9. OBTAINING THE BEST MEASUREMENT

The Rogowski coil should be positioned so that the conductor under test is encircled by the coil but is not adjacent to the cable attachment (see picture below). The diagram below shows the direction a positive current should pass through the coil loop in order to obtain a positive output voltage between output terminals S1 to S2. The RCTi has been calibrated with the conductor near the centre, and this is the ideal position.

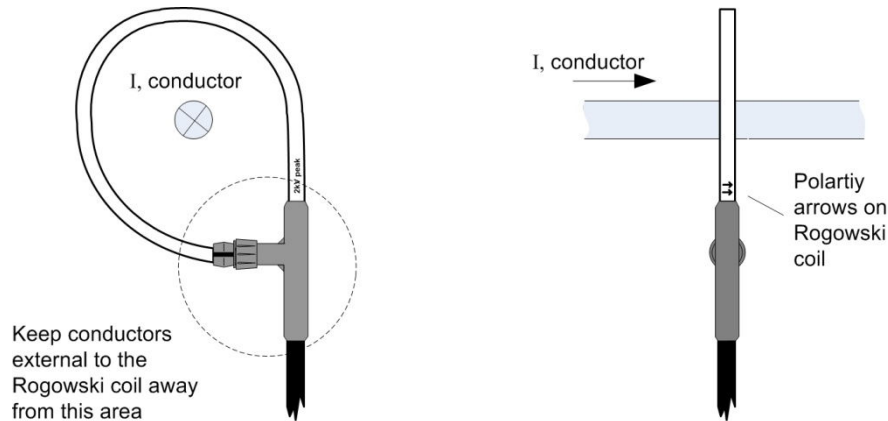

The sensitivity of the RCTi to currents that do not pass through the coil is very small, provided that such currents are no greater than the RCTi rating or such currents are relatively distant from the coil. In the vicinity of a multi-turn inductor the 'H' field is far stronger than from a single conductor carrying the same current, and such positions should be avoided.

Similarly if there is a surface with a high voltage very close to the coil, and the voltage is subject to high rates of change (e.g. several 100 V/ $\mu$ s) or high frequency oscillations in the MHz range, then measurement error can arise due to capacitive coupling to the coil.

As a check on any unwanted response to adjacent fields, it is wise to display the output of the RCTi when close to (but not encircling) the conductor whose current is to be measured. This will reveal the magnitude of any unwanted response to currents close to but outside the coil.

## **10. CLEANING AND DECONTAMINATION**

To prevent surface contamination of the Rogowski coil and cable inspect regularly. To clean the coil and cable use a mild detergent and water to remove any contamination, wipe with clean water to remove the detergent and dry thoroughly with a clean cloth. Obviously the RCTi must be disconnected from any external circuit prior to cleaning.

PEM accepts no responsibility for the use of any other cleaning solvents or cleaning methods.

## **11. WARRANTY**

The coil is guaranteed to be free from defects due to materials and workmanship for 12 months and the integrator for 24 months from the date of despatch from Power Electronic Measurements Ltd. In the event of a defect or incorrect operation of the unit where the transducer has not been misused the RCTi should be returned to PEM with all freight charges to be paid by the customer. Correction shall be in the form of repair or replacement.

## **12. RETURNING RCTi FOR RECALIBRATION OR REPAIR**

If it is necessary to return the RCT to PEM for repair whether or not under warranty please contact PEM in advance for shipping instructions (see below for contact details). To facilitate customs clearance it is important to follow the correct procedure otherwise import tax will be charged. PEM will not accept units sent for recalibration or repair if the relevant procedure is not followed.

---

For technical updates or enquiries and the latest product releases please consult

[www.pemuk.com](http://www.pemuk.com)

### ***POWER ELECTRONIC MEASUREMENTS Ltd.***

Gloucester House, Wellington Street, Long Eaton, Nottingham, NG10 4HT, U.K.

Tel: +44 115 946 9657

Fax: +44 115 946 8515

Email: [info@pemuk.com](mailto:info@pemuk.com)