



# Webinar: Long Term Magnetic Field Monitoring for Space Weather Monitoring and GIC Forecasting



**Ludovic Letourneur, PhD**  
Senior Applications Engineer  
GMW Associates



**Jenn Gannon, PhD**  
GMD Lead  
Computational Physics, Inc.



**Mike Henderson**  
Owner and Principal Engineer  
GIC Magnetics

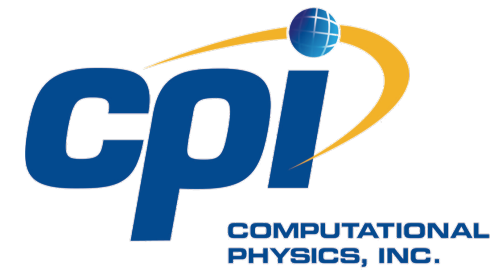

# Agenda

- Induction due to space weather and impact on man made installations.  
*Jenn Gannon, CPI*
- Details on fluxgate magnetometer benefits for monitoring of the Earth's field variations. *Ludovic Letourneur, GMW*
- Hardware integration: Data transfer and processing. *Mike Henderson, GIC Magnetics*
- Use of data for GIC monitoring/prediction: Application to power networks and link to upcoming regulations. *Jenn Gannon, CPI*
- Use of magnetic data for magnetic storm monitoring and application to the oil & gas directional drilling industry. *Ludovic Letourneur, GMW*
- What's next: Integration of electric current information to the data stream.  
*Ludovic Letourneur, GMW*
- Questions and Answers

# Space Weather and Infrastructure

Jennifer Gannon  
Computational Physics, Inc.  
*[gannon@cpu.com](mailto:gannon@cpu.com)*



# Space weather is all about magnetic fields.

*Space weather is the interaction between the Sun and the Earth.*

- Aurora
- Van Allen radiation belts
- Magnetosphere, ionosphere
- Solar wind
- Solar activity (flares, sunspots, etc)

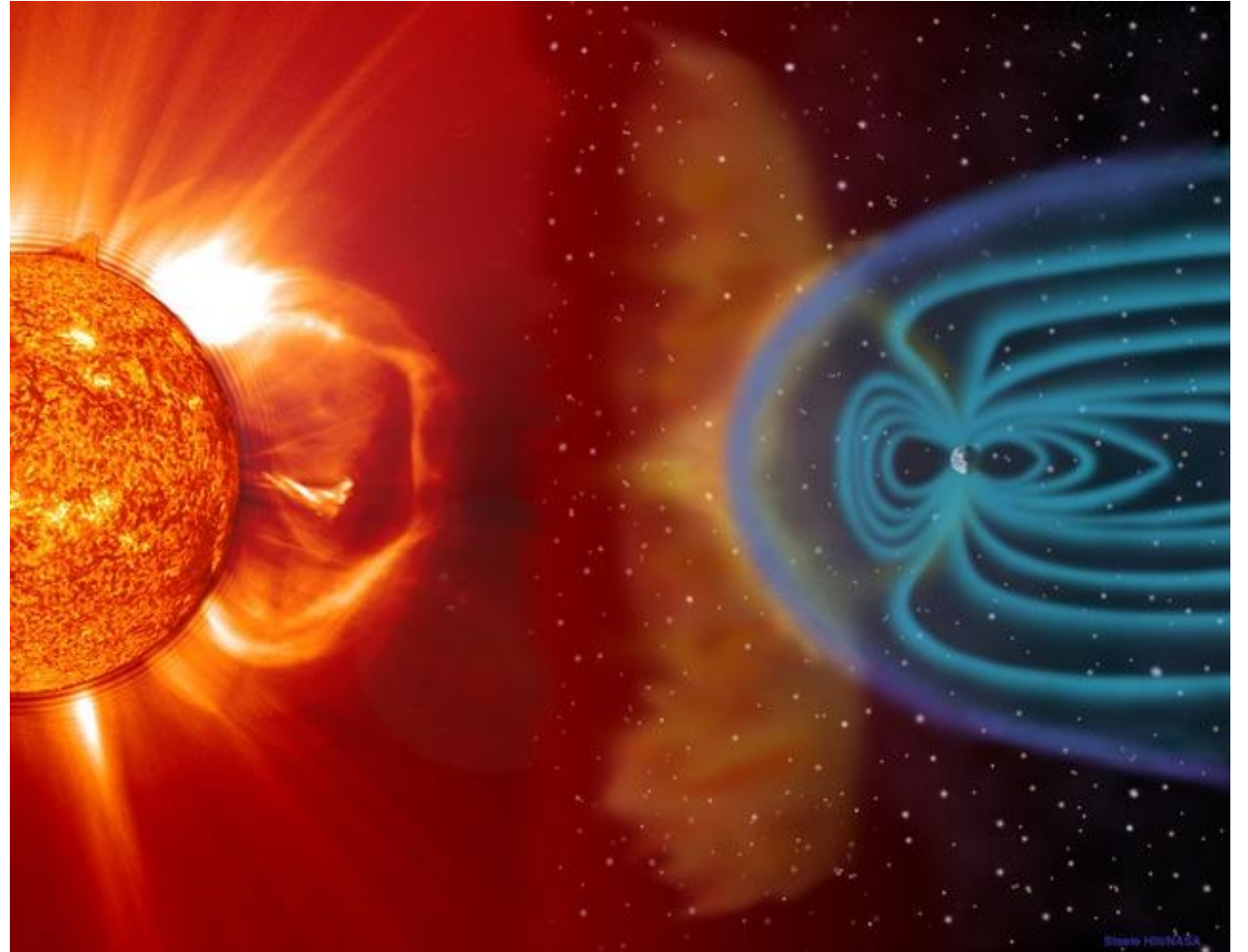
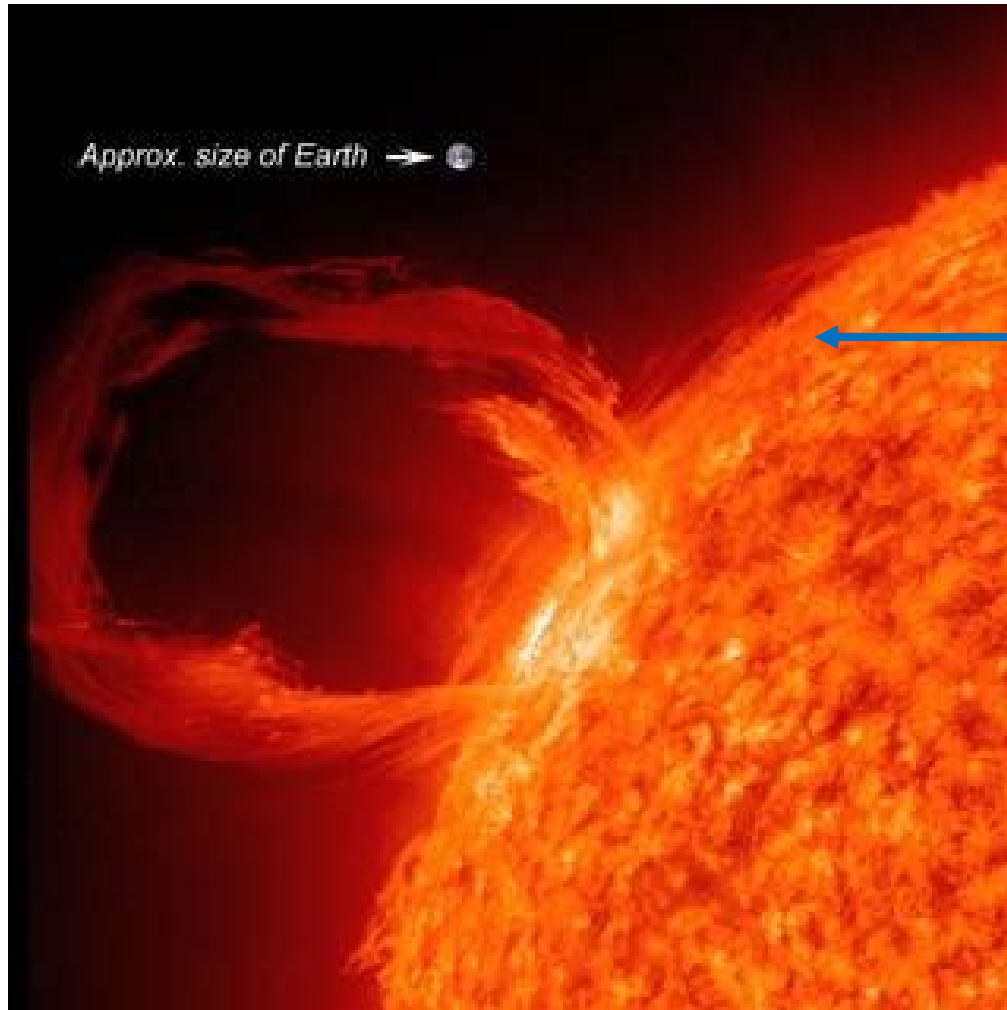
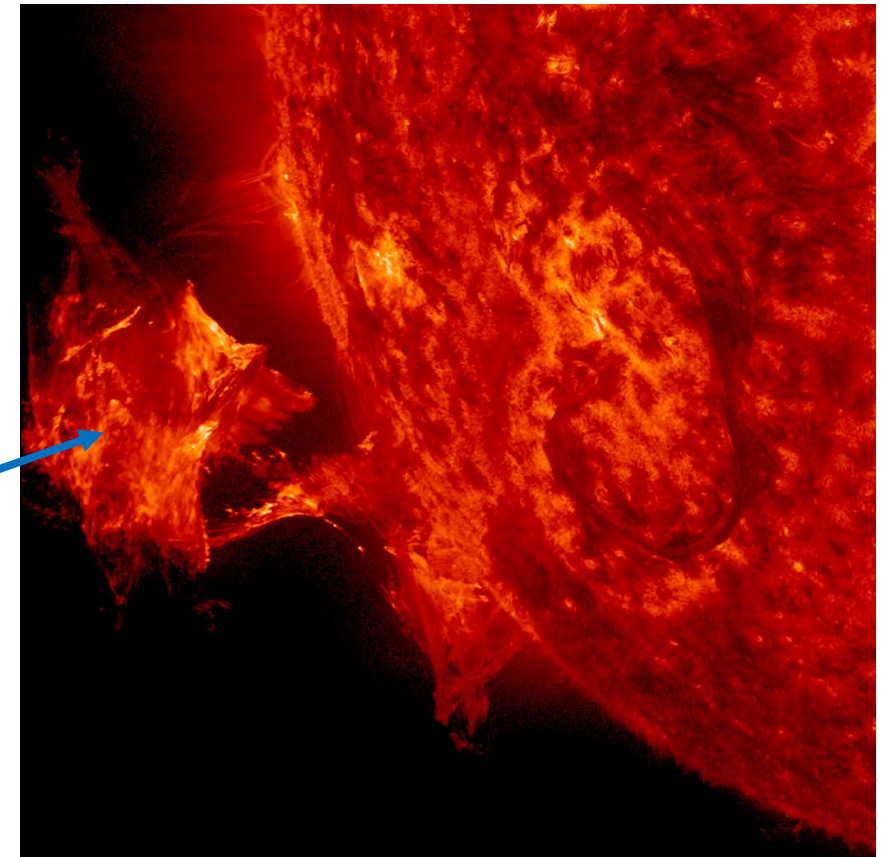

Image credit: NASA

# There are different solar effects that produce GMDs.



Prominence



CME

Image credit: NASA

# CMEs cause the largest GMDs.

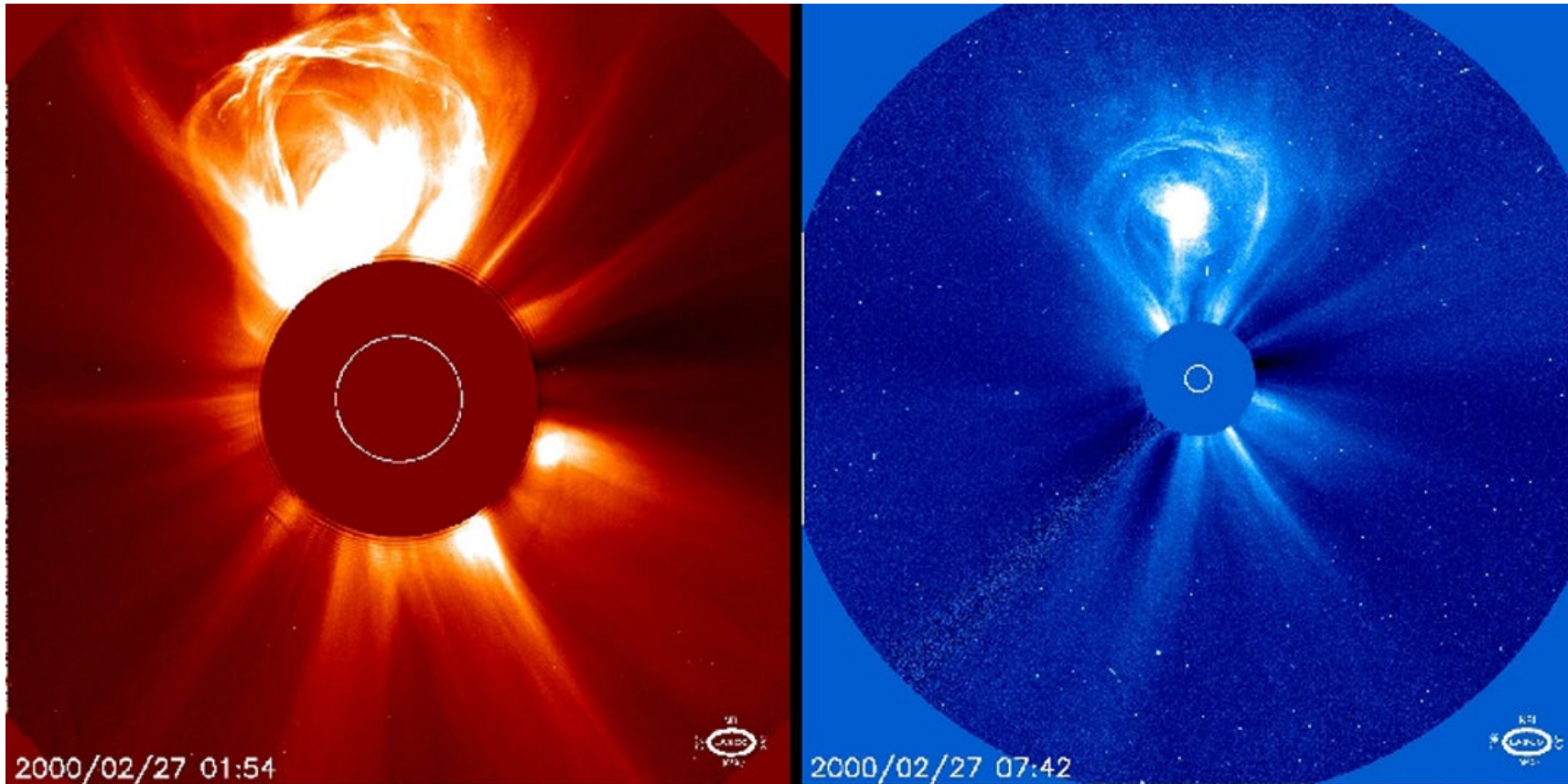
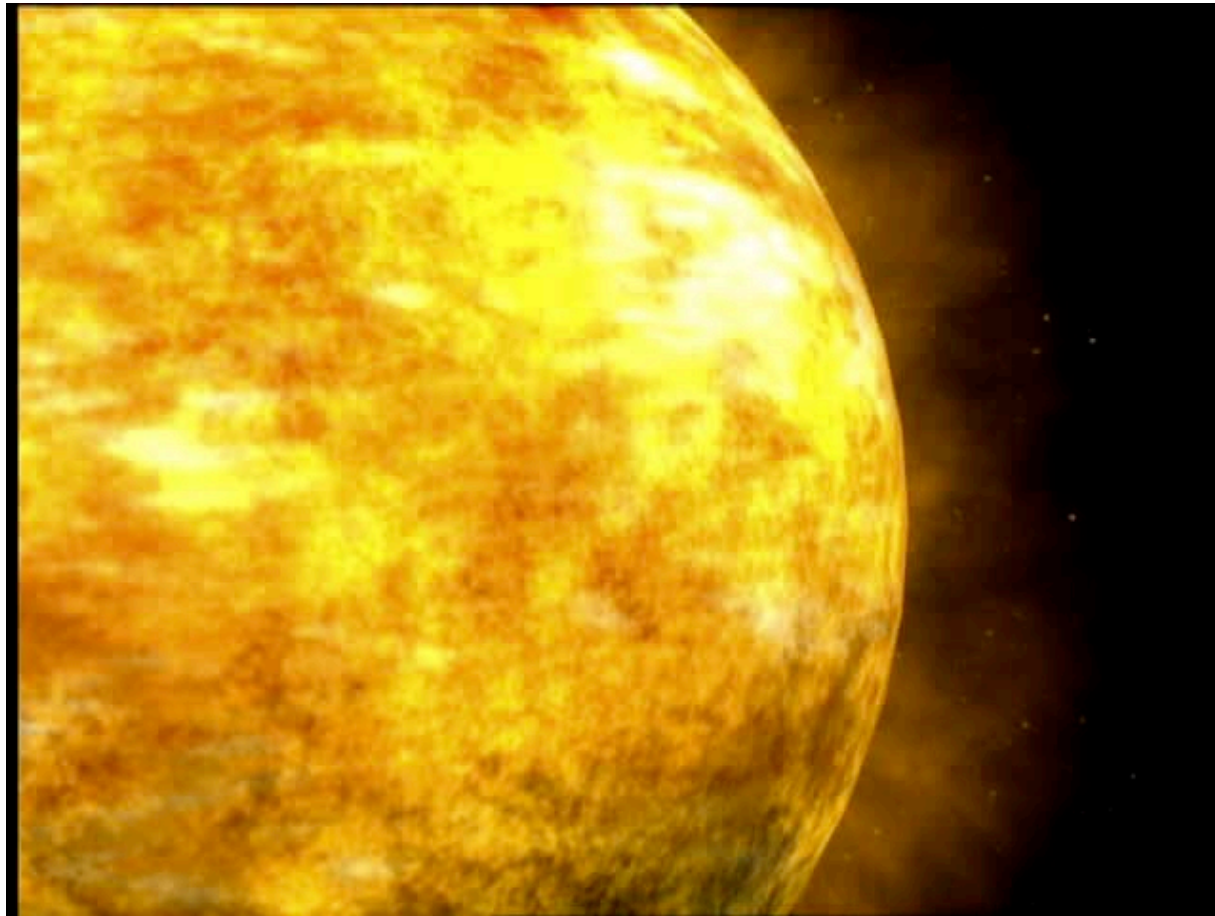

Image credit: NASA

- Fast speed in the solar wind
- High density plasma
- Very large relative to the Earth
- Uncertainty in direction (towards/away from Earth)

# During a geomagnetic storm, the magnetic field changes rapidly.



The Earth's magnetic field is our shield against plasma from the Sun.

Earth and solar wind magnetic fields in the same direction (both North) -> compression.

Earth and solar wind magnetic fields in the opposite directions -> reconnection.

*Image credit: NASA*

# A Geomagnetic Storm is a reconfiguration of fields.

- "Active" geomagnetic field – actually a fairly specific definition
- Small storms happen regularly.
- The effect is a rapidly changing magnetic field on the ground.



*Image credit: NASA*



# Changing magnetic fields interact with the Earth to produce electric fields.

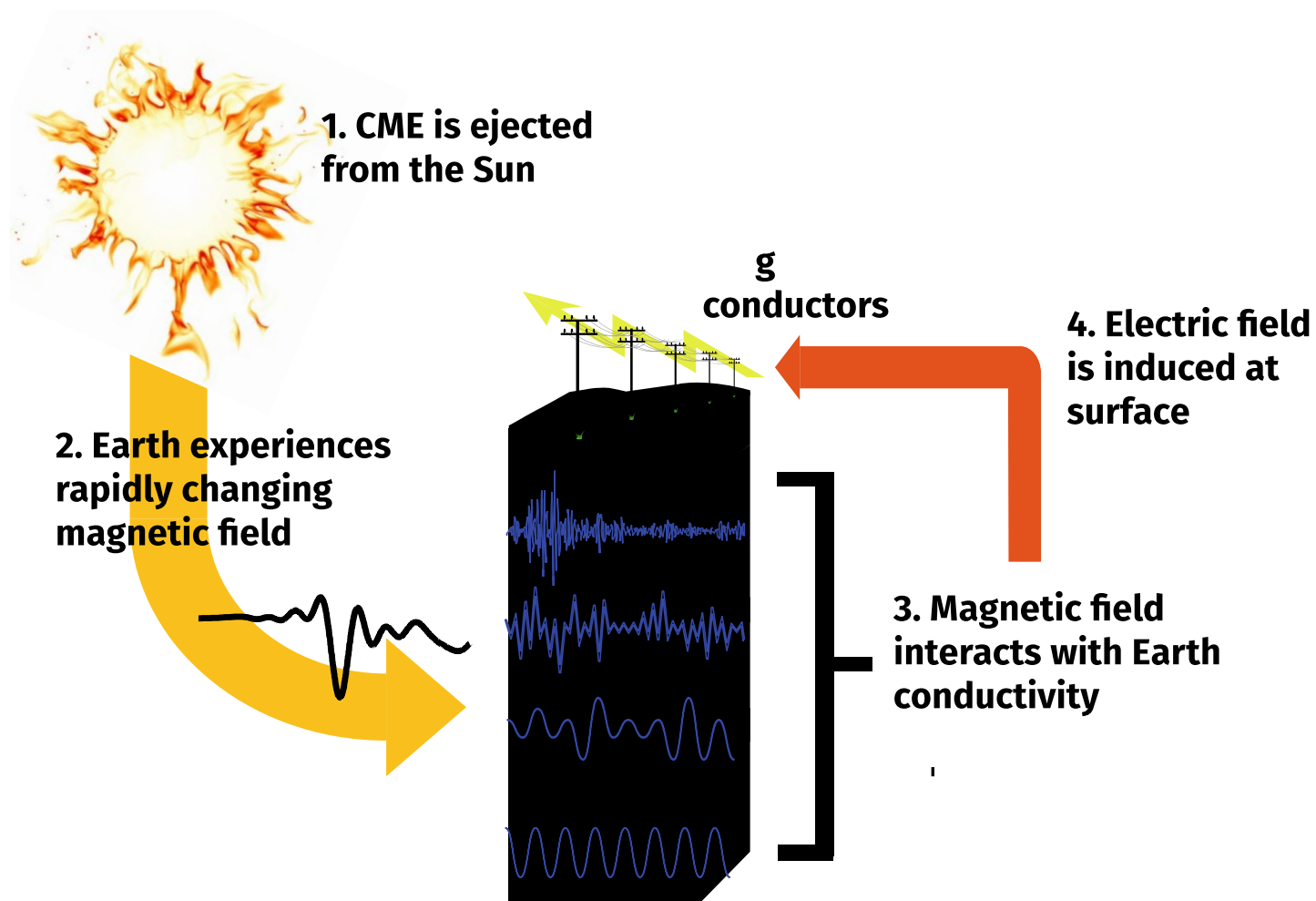

Image: CPI

# Introduction to Fluxgate Magnetometers

## Presented by:

Ludo Letourneur  
Senior Sales Engineer  
GMW Associates  
[ludo@gmw.com](mailto:ludo@gmw.com)

**GMW** *Associates*

Fluxgate sensors measure the amplitude of the magnetic field along the axis of the fluxgate element rather than just the total amplitude of the magnetic field – decompose the field along North, East and Down component.

From Boteler, D. H. (2019). A 21st century view of the March 1989 magnetic storm. *Space Weather*, 17, 1427–1441. <https://doi.org/10.1029/2019SW002278>

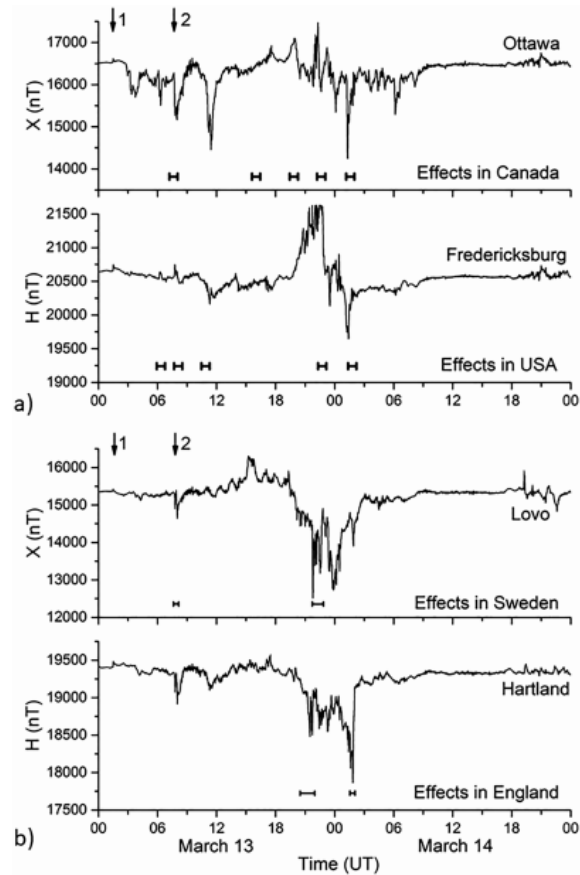

**Figure 8.** Magnetic disturbances and effects on power systems during 13–14 March 1989 in (a) North America and (b) Europe (the different vertical scales). Horizontal bars indicate the times of power system effects. Black arrows indicate the times of the storm sudden commencement.



Fluxgate are perfect to measure Earth's field amplitude and variations from sub-nT in amplitude – typically the amplitude change seen in Space Weather from nT to hundreds or even thousands of nT at ground level.

The fluxgate principle date back from the mid 1930's and aims to measure the magnetic flux density –  $B$  in the direction of the fluxgate. Three-axis achieved by combining three fluxgate elements orthogonally from one another.

Multiple fluxgate designs exists – ring core, single linear cores, twin cores.

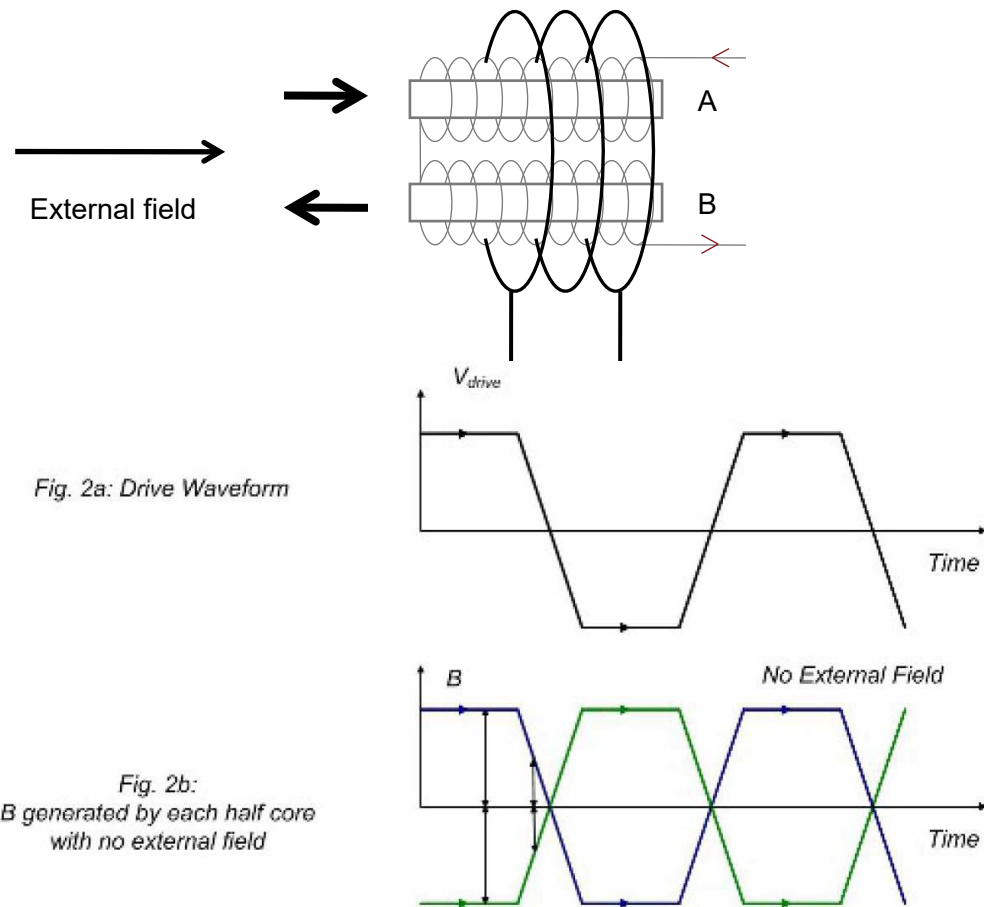

Bartington uses a twin core setup. Benefits includes better immunity to excitation signal.

Frequency of measurement (~3kHz) dependent on the sensor's excitation frequency (~16kHz)

Fig. 2c:  
B generated by each half core in external field

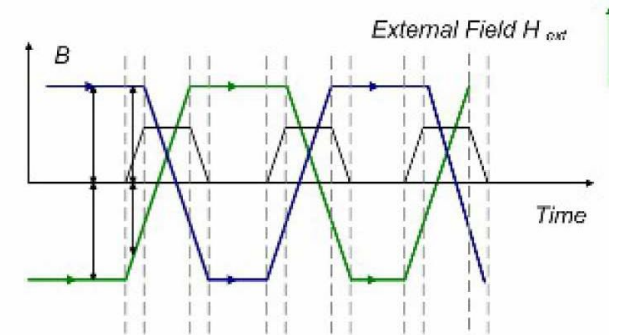
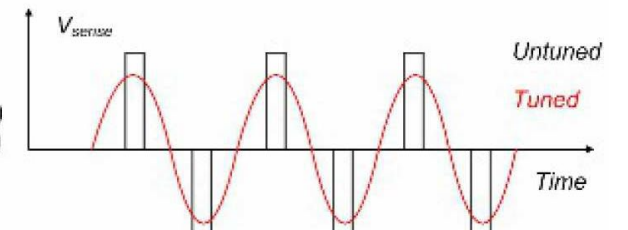
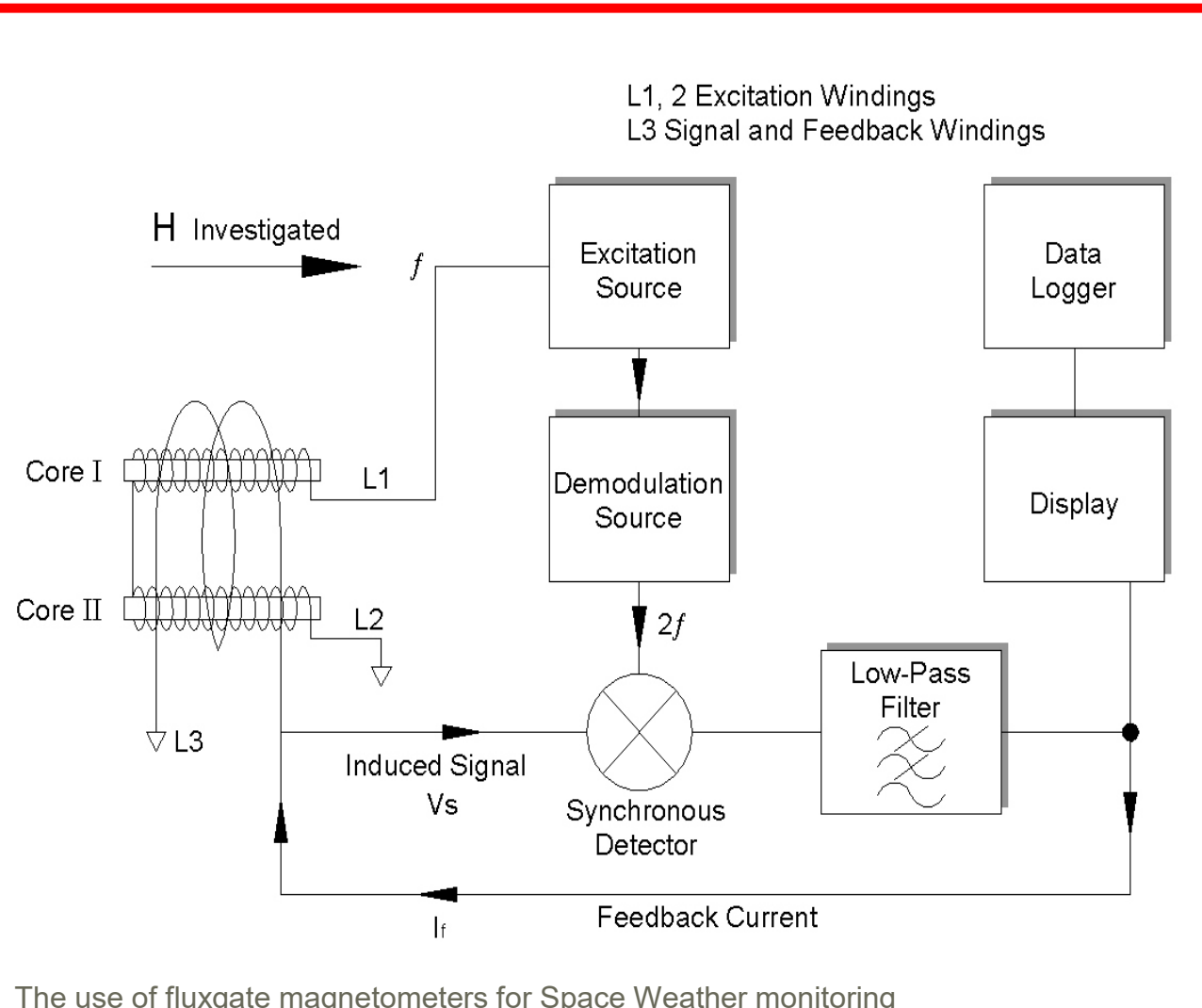

Fig. 2d:  
Voltage induced in the sense winding (black)  
Resultant voltage if the sensor is tuned (red)



Fluxgate run in closed-loop mode – the induced voltage is used to provide a feedback current into the pick up coil. This ‘cancel out’ the external field so that the fluxgate is always in a null mode (no induced voltage). The external field is directly proportional to the feedback current read across a precision scaling resistor



Fluxgate in closed-loop offer excellent linearity mainly dependent on the Op-Amp used to drive the current in the feedback loop.

Noise on the Bartington fluxgate is typically less than 10pT. Care needs to be taken siting the magnetometers away from human-made interferences and insulate them from temperature variations

Due to their offset, the sensors have some small errors for absolute measurements but are ideal at measuring small field variations over time. Offset are extremely stable over time once warm up period has passed.

Mag-13 are best suited – low offset, noise

For low power setups use Mag649

For cost over performance is important - Mag690

Both these options have higher offsets and noise, as well a higher orthogonality error.

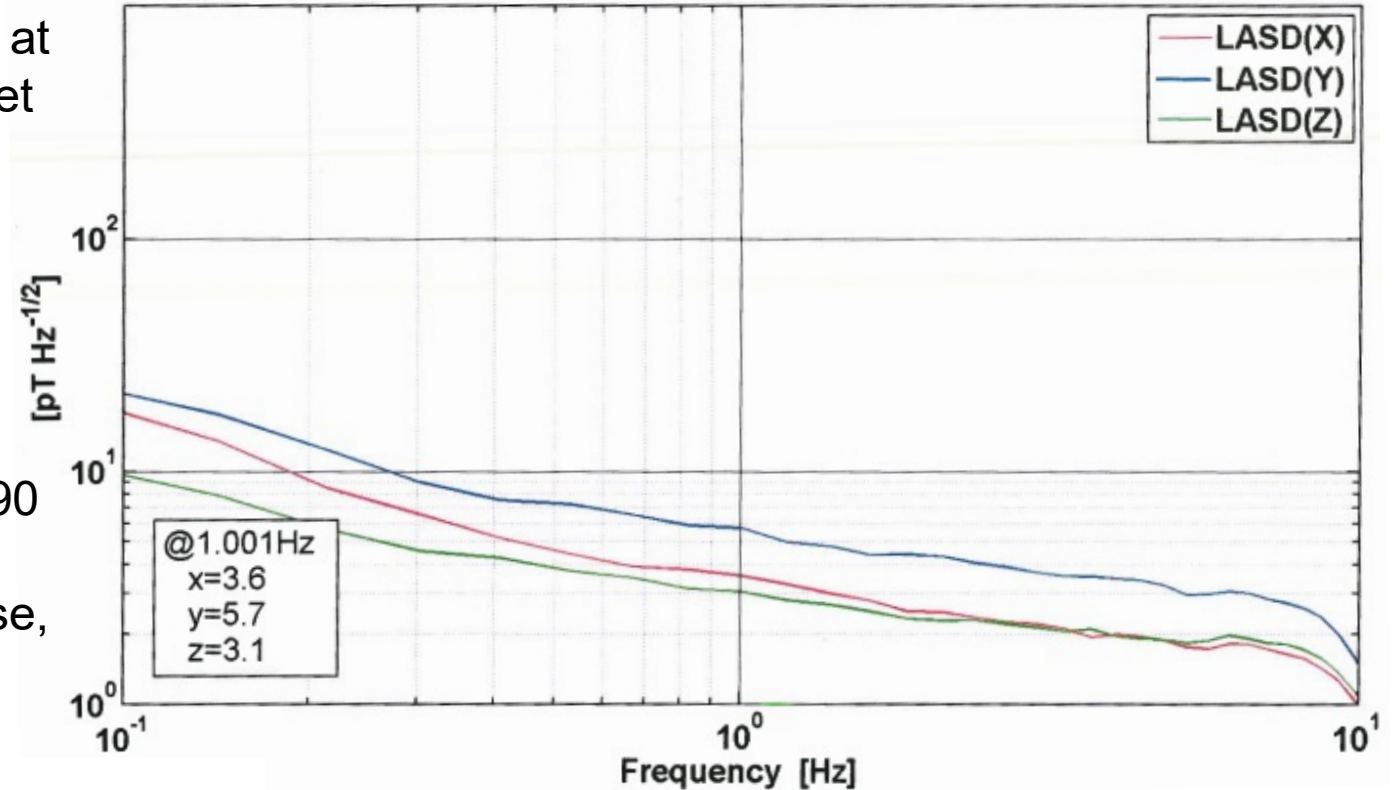

Noise plot of Mag-13 Low noise



Example of use: Bureau of Meteorology - Australia  
[https://www.sws.bom.gov.au/World\\_Data\\_Centre/2/3/1](https://www.sws.bom.gov.au/World_Data_Centre/2/3/1)  
Image from the Bureau of Meteorology – link above.



The use of fluxgate magnetometers for Space Weather monitoring

USGS: This is part of a joint magnetic/seismic survey and using the magnetic data to correct the effect space weather has on the seismic network.

<https://pubs.geoscienceworld.org/ssa/bssa/article-abstract/110/5/2530/587721/Magnetic-Field-Variations-in-Alaska-Recording?redirectedFrom=fulltext>

Data from USGS – Adam Ringler  
[https://www.usgs.gov/natural-hazards/earthquake-hazards/science/auroras-and-earthquakes-strange-companions?qt-science\\_center\\_objects=0#qt-science\\_center\\_objects](https://www.usgs.gov/natural-hazards/earthquake-hazards/science/auroras-and-earthquakes-strange-companions?qt-science_center_objects=0#qt-science_center_objects)

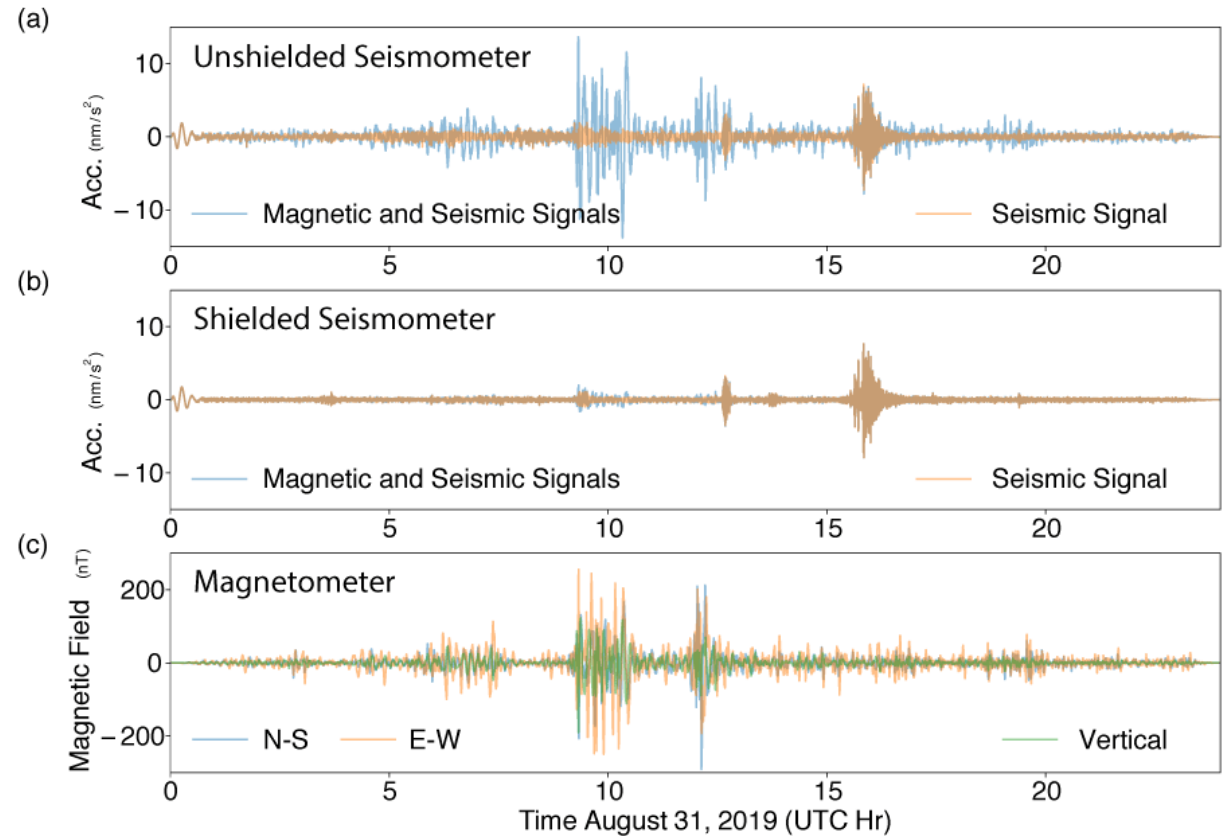



# Integration of Fluxgate Magnetometers into Measurement Systems

Mike Henderson



Not just a sensor ...



Magnetometers used for GIC estimation need to be **physically remote**, and are **highly sensitive**

**GIC** Magnetics

You need to keep the sensor away from iron

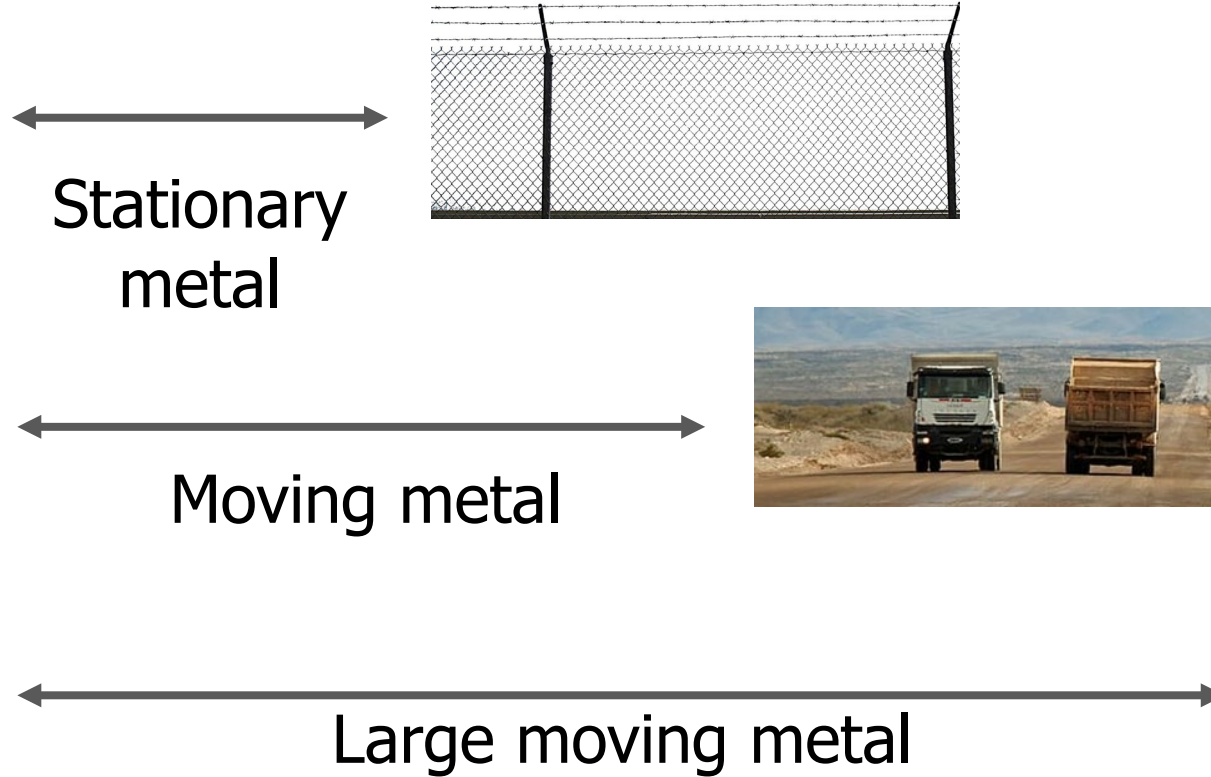

You need to mount the sensor carefully

---



**No vibration**

Level

Oriented  
**True North**

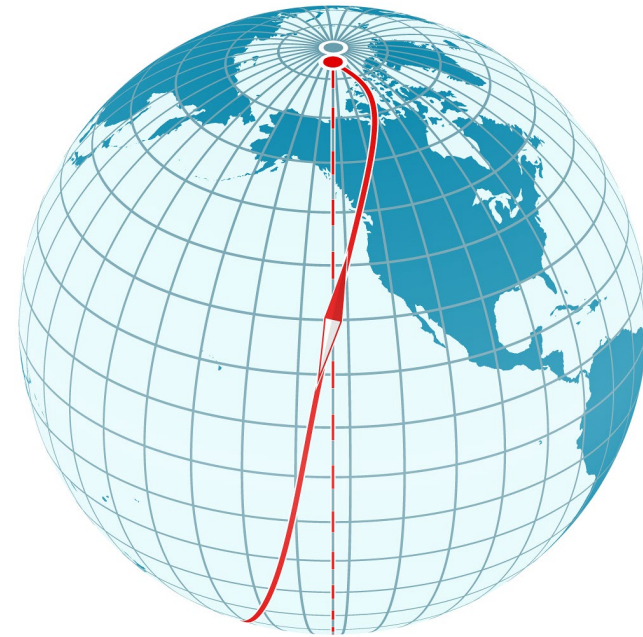

# You need to handle temperature changes

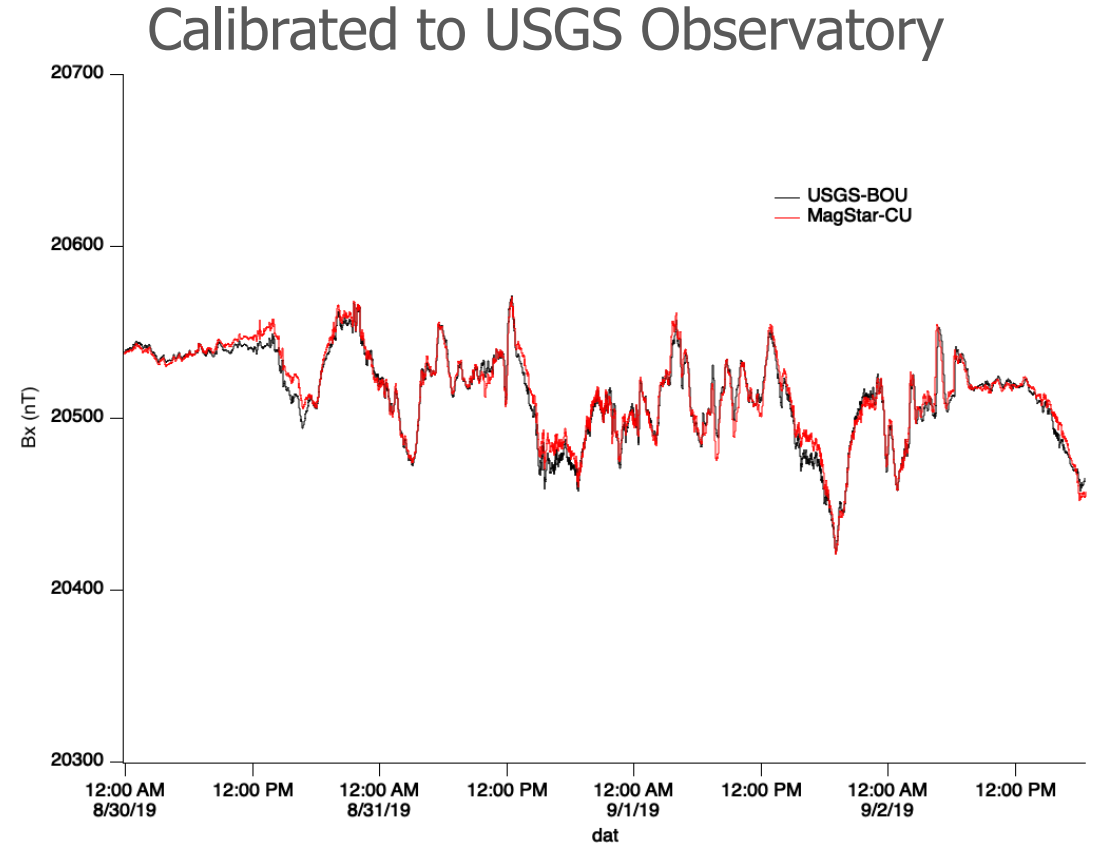
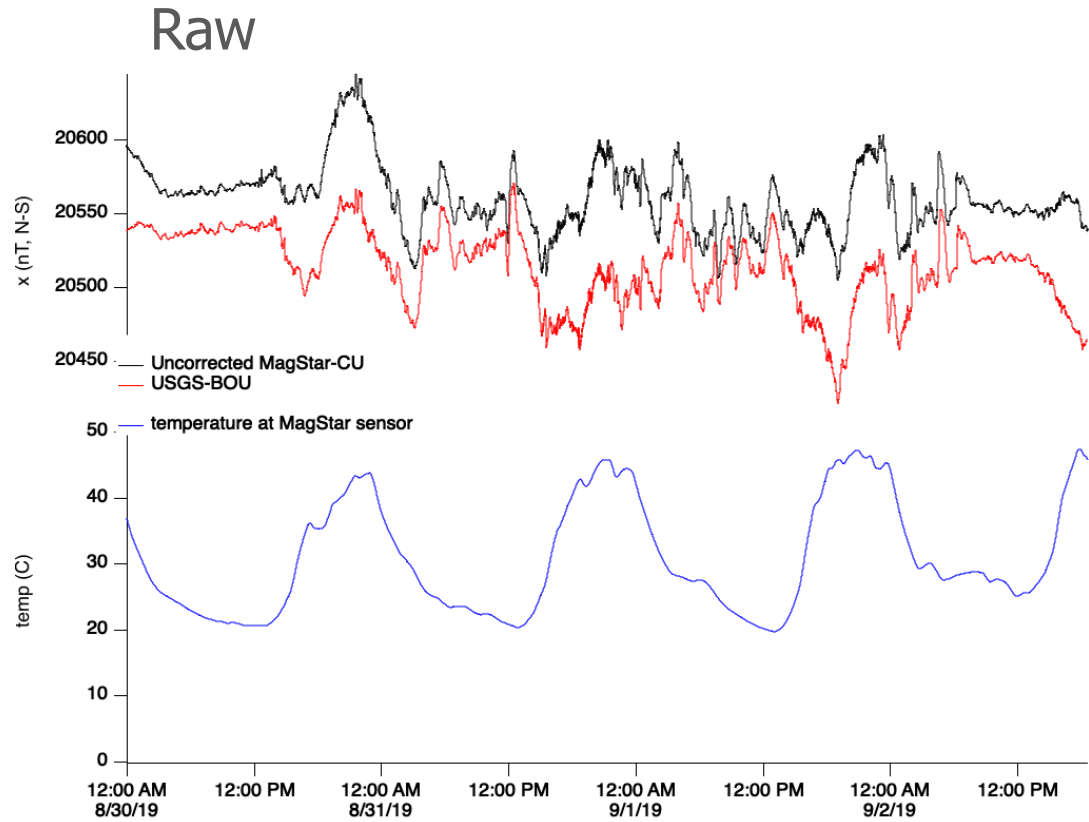

You need to time align the data

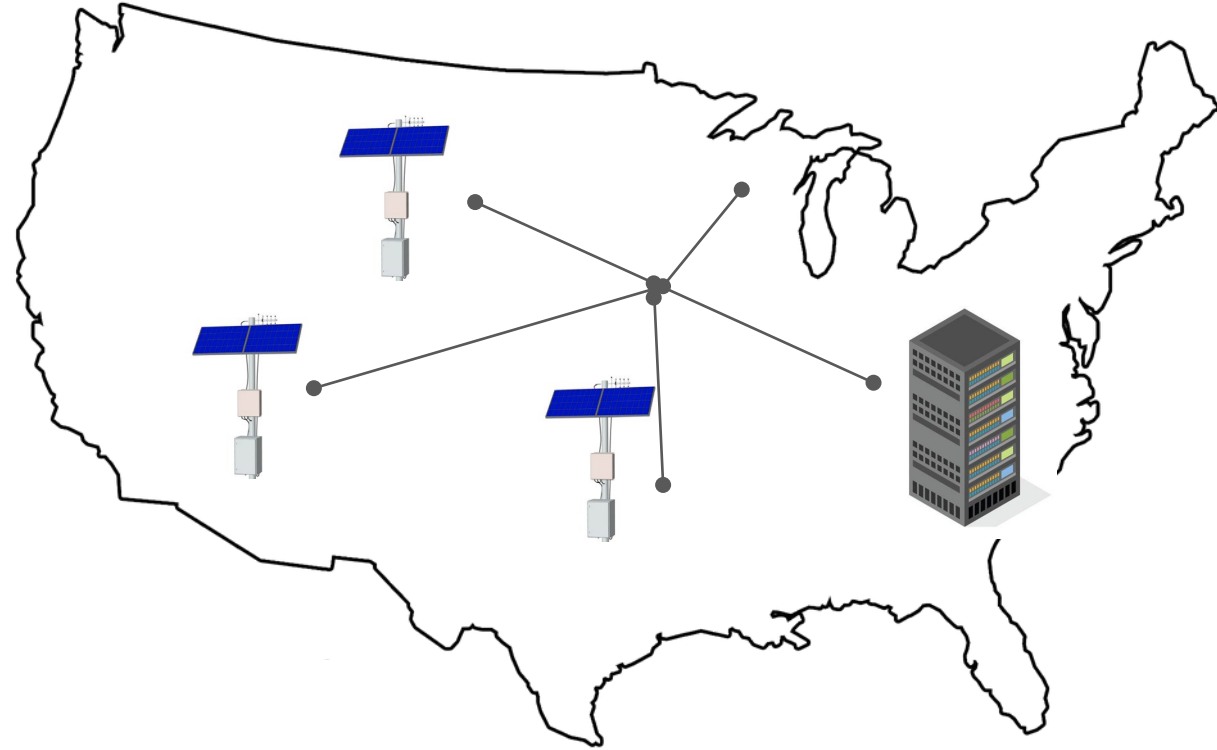
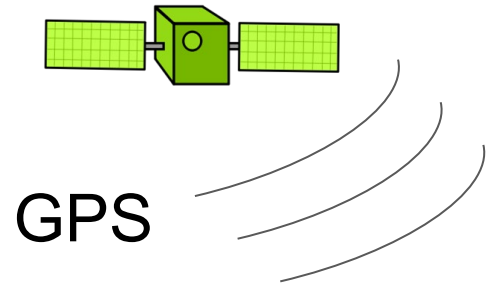

Timestamp data **at the sensor** to avoid network timing jitter

You need to power the system

6 Watts ...



continual  
operation in mid  
winter ...

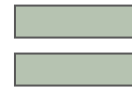
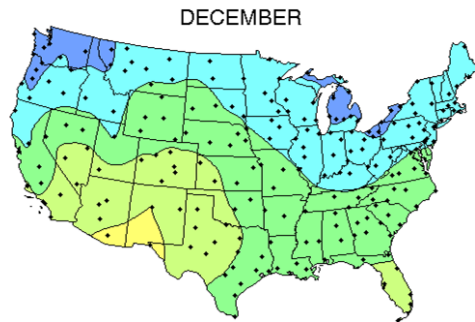

... **360 Watt** solar  
( 22 ft<sup>2</sup> )



You need to get the data to a server

---



Physical security can be difficult to guarantee at remote sites

Mitigate security risks of a **physically compromised** station

Cellular or point-to-point ethernet link

If cellular, M2M accounts



You need to store the data

---

Things to consider:

- Probably want read-only access for most people
- Data rate for 1 station = 8 GB per year

Permanent, autonomous sensor stations

# MagStar

Purpose-built magnetometer station for GIC estimation

Featuring **Mag13-MSS**

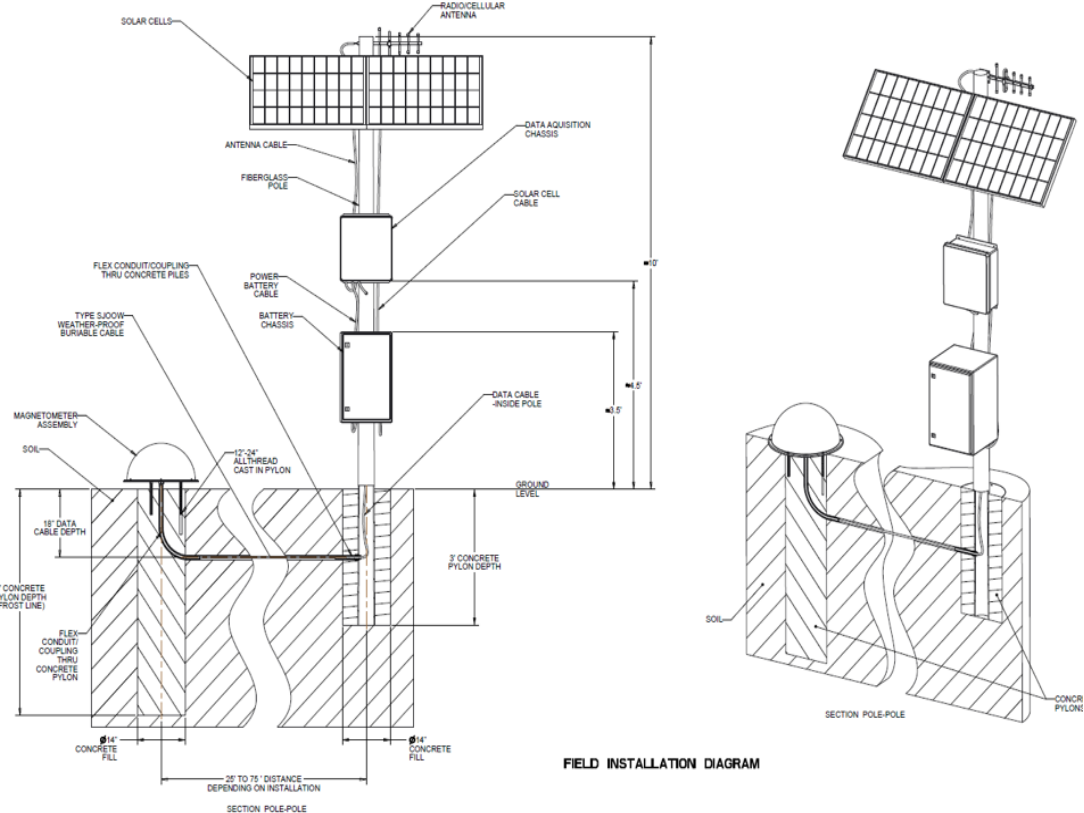

# Impacts on Power Systems and FERC Regulations

Jennifer Gannon  
Computational Physics, Inc.  
*[gannon@cpu.com](mailto:gannon@cpu.com)*



# FERC TPL-007 Regulation (Magnetic Fields)

⇒ **Measure magnetic field and geomagnetically induced currents (GICs) -- July 2021**

**Why? Know local hazard conditions and use in model validation.**

⇒ **Model validation of power system model -- July 2022**

**Why? Accurate models mean that planning scenarios are accurate.**

# TPL-007 Model Validation Steps

1. Measure **magnetic field** and **GIC** at the same time.
2. Calculate **electric field** from magnetic field and earth model.
3. Estimate **GIC** using electric field as input to system models.
4. Compare measured and modeled GIC

Reference: EPRI Model Validation Guide (with examples): Guidance for Validation of GIC models, EPRI Technical Update, EPRI, Palo Alto, CA, 2020 : 3002017897.

# 1. Measure magnetic field (and GIC)

## Best practices for magnetic field data:

- 10 second (or shorter) cadence measurements
- Remove spikes and bad data
- Magnetic field measurements taken within 150 – 200 miles of GIC measurements

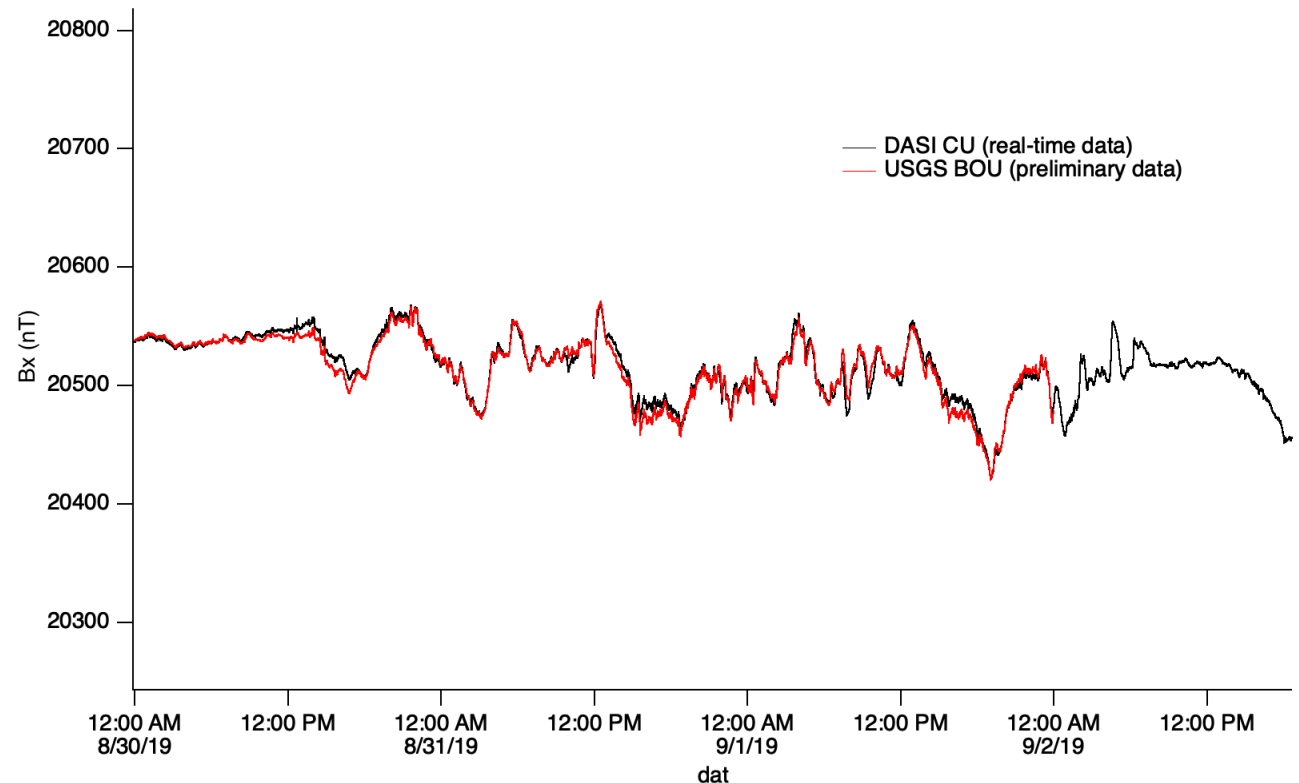

# 2. Calculate the electric field

There are multiple ways to do this:

- Scaling factors:
  - Used for scaling electric field from another location.
- Uniform electric field
  - Updated EPRI ground response transfer functions recommended
  - Every electric field point will be the same across your region, and will point in the same direction
- Non-uniform electric field
  - Most useful in high-response regions (Maine, mountain regions, Minnesota).  
(CPI's AVERT model - <http://gmd.cpi.com>)

EPRI earth response models: Improving conductivity models for Geomagnetically Induced Current Estimation, EPRI Technical Update, EPRI, Palo Alto, CA, 2018: 3002014856.

# 3. Estimate GIC using electric field as input to system model

- System models, like PowerWorld or PSSE, can use electric field inputs to model GICs
- Note that some system modeling software uses DIFFERENT NOTATION for N-S and E-W!!

# 4. Compare measured and modeled GIC

- Make sure you have a good data
- Don't expect a perfect, point by point match.



# Estimating GIC – Decent match

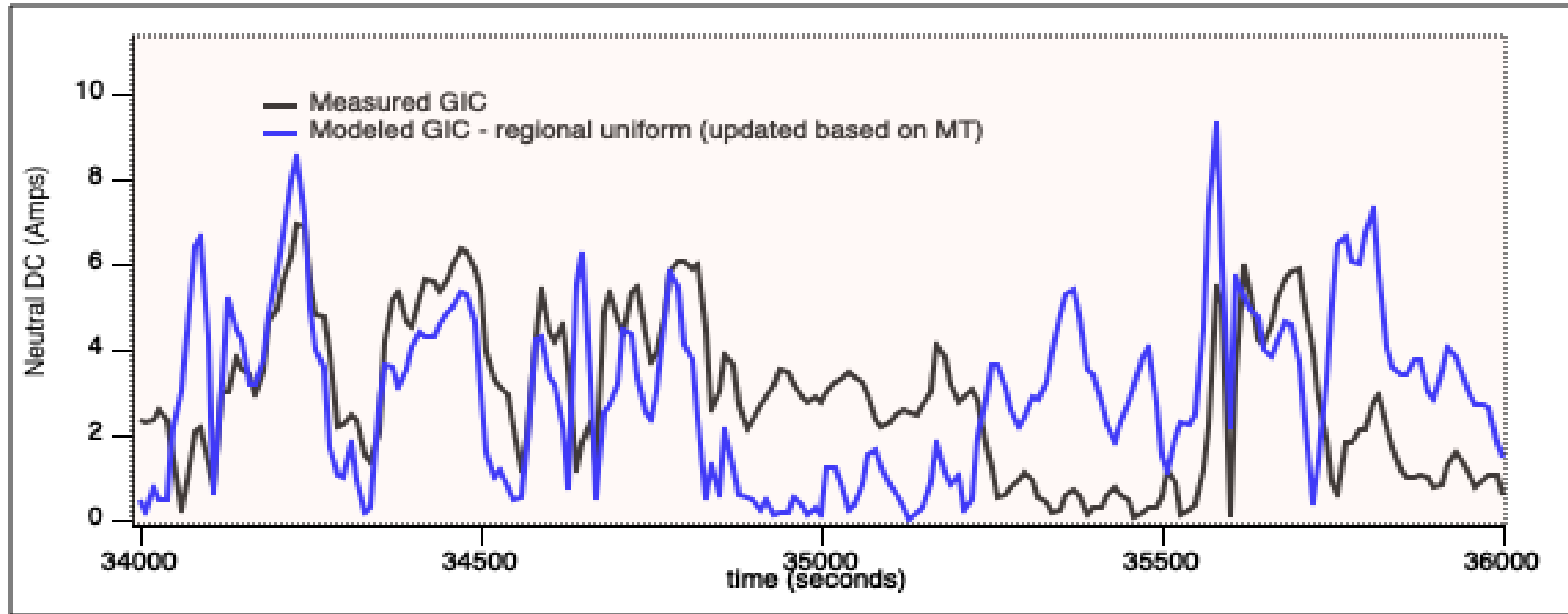

Reference: EPRI Model Validation Guide (with examples): Guidance for Validation of GIC models, EPRI Technical Update, EPRI, Palo Alto, CA, 2020 : 3002017897.

# Estimating GIC – Not as good.

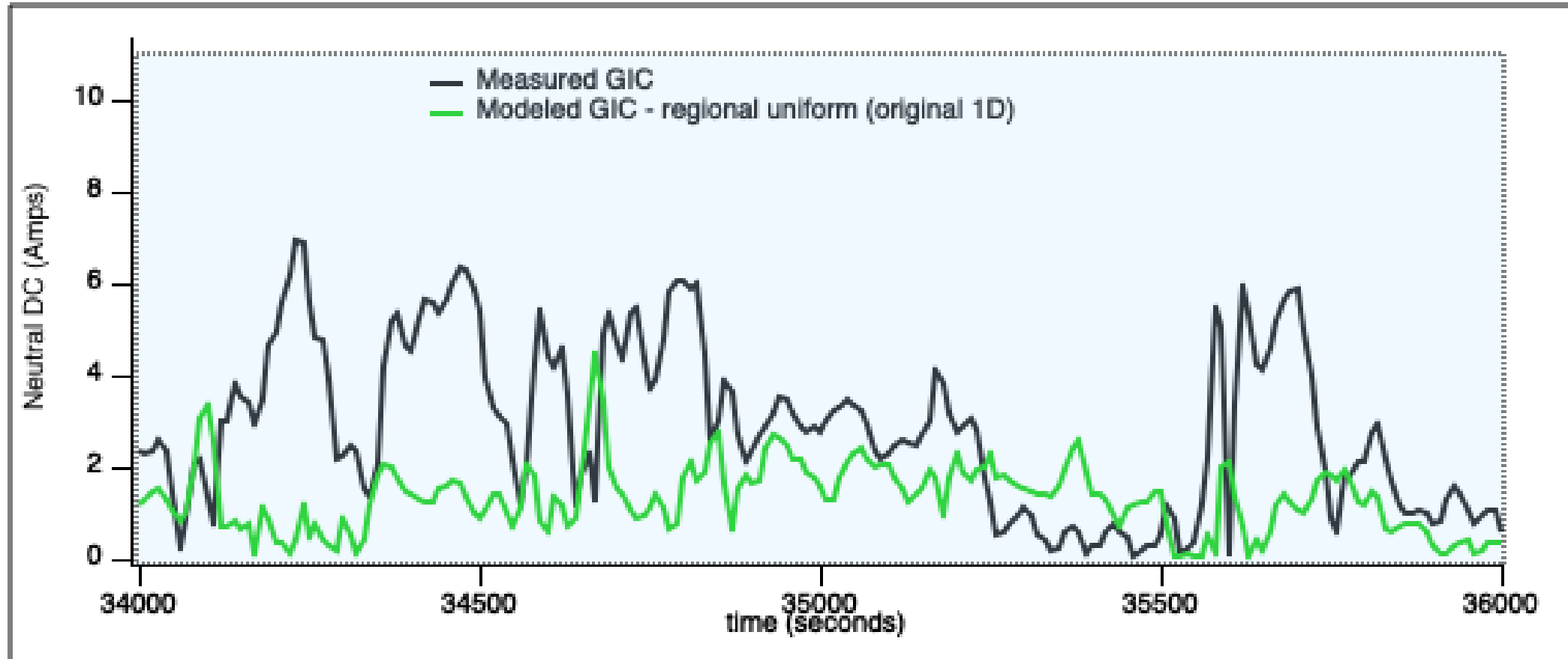

Reference: EPRI Model Validation Guide (with examples): Guidance for Validation of GIC models, EPRI Technical Update, EPRI, Palo Alto, CA, 2020 : 3002017897.

# Top causes of GIC estimation errors

## 1. Inaccurate/outdated substation grounding values

**Solution:** update/improve system model.

## 2. Magnetic field is inaccurate in intensity or direction

**Solution:** use local magnetometer. Make sure you have good data!

## 3. Local geologic complexities

**Solution:** improve electric field calculations or ground conductivity models.

# Resources

Feel free to reach out to me with questions, I'm happy to help, if I can:  
[gannon@cpi.com](mailto:gannon@cpi.com)

EPRI Model Validation Guide (with examples): Guidance for Validation of GIC models, EPRI Technical Update, EPRI, Palo Alto, CA, 2020 : 3002017897.

EPRI earth response models: Improving conductivity models for Geomagnetically Induced Current Estimation, EPRI Technical Update, EPRI, Palo Alto, CA, 2018: 3002014856.

Find your geomagnetic latitude on a map:  
<http://gmd.cpi.com/resources.html> or <http://magneticlatitude.com> .

# Magnetic Storm monitoring

Application to the Oil & Gas Directional  
Drilling industry

**GMW** *Associates*

## Presented by:

Ludo Letourneur  
Senior Sales Engineer  
GMW Associates  
ludo@gmw.com



# Rapid change of field during geomagnetic storms impact accuracy of magnetometers used in directional drilling package.

- Change in amplitude can lead to temporary change in field azimuth and inclination – data which are relied on to direct the drilling tool in the borehole.
- Having local ground magnetometer data can help determine periods of heavy disturbances. Corrections or alert can be obtained/raised from the magnetometer data.
- Proximity to the drilling site is essential as the further from the site you are, the less useful the data become – geomagnetic storms can see their effect decrease relatively rapidly especially when travelling further away from the poles.

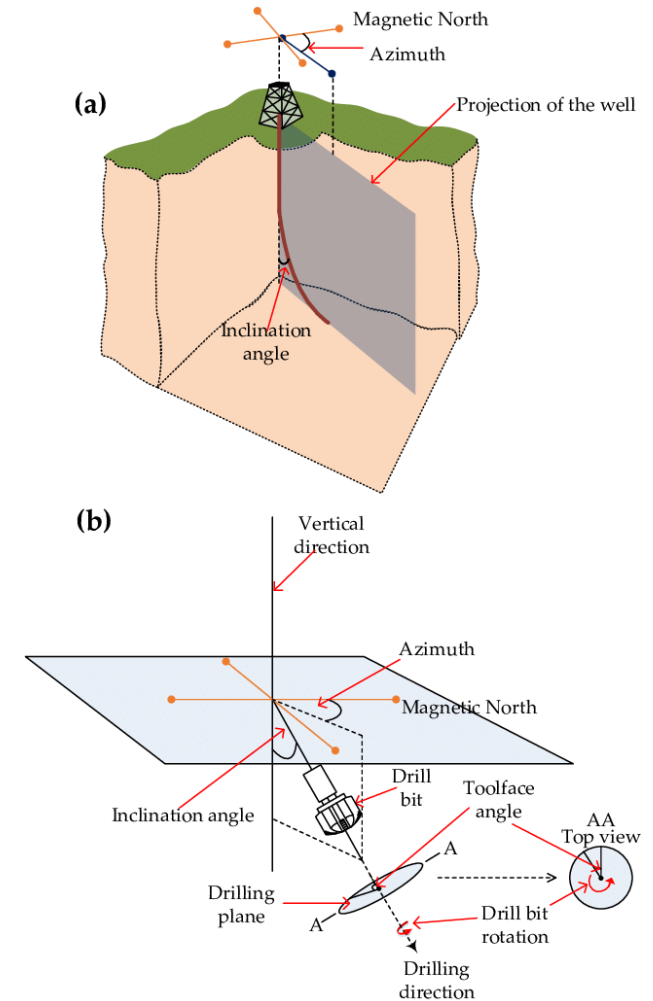

For directional drilling – sensors typically have a 50nT precision and aim to achieve ~0.1 degrees in directional accuracy.

- Magnetic anomalies from storms can be in the range or in excess of hundreds of nT
- The angular range that can be observed could be up to 0.2-0.5 degrees in excess of the desired accuracy.
- Increased error can lead to
  - an increased risk of collision
  - less optimal intersection with the target reservoir

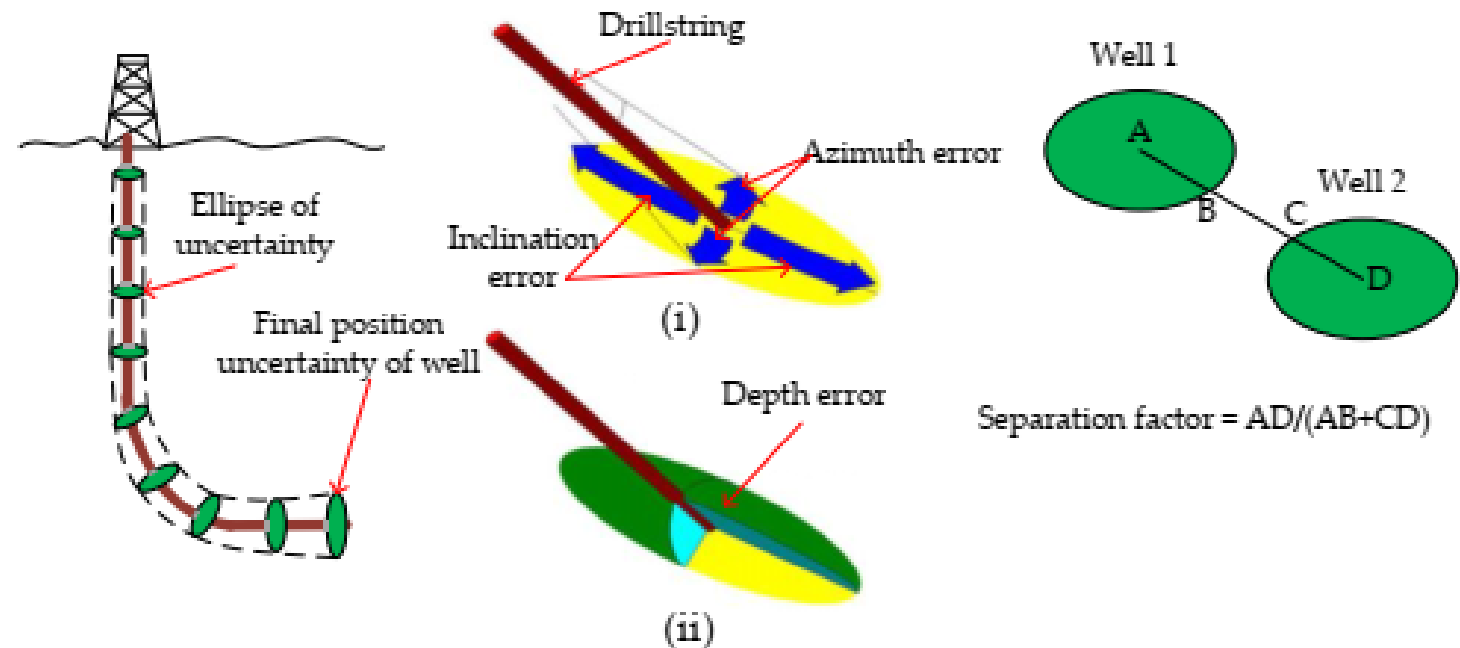

From Gooneratne et al., 2017. Downhole Applications of Magnetic Sensors. Sensors, 17, 2384.

# Impact on magnetic ranging: Magnetic ranging is the technology used to accurately position multiple wells in relation to one another (or intersect wells)

- Active ranging uses an AC source and will therefore be more immune to the geomagnetic storm.
- Passive ranging uses well casing as the 'magnetic source' – this is purely DC and will be greatly affected by geomagnetic storms

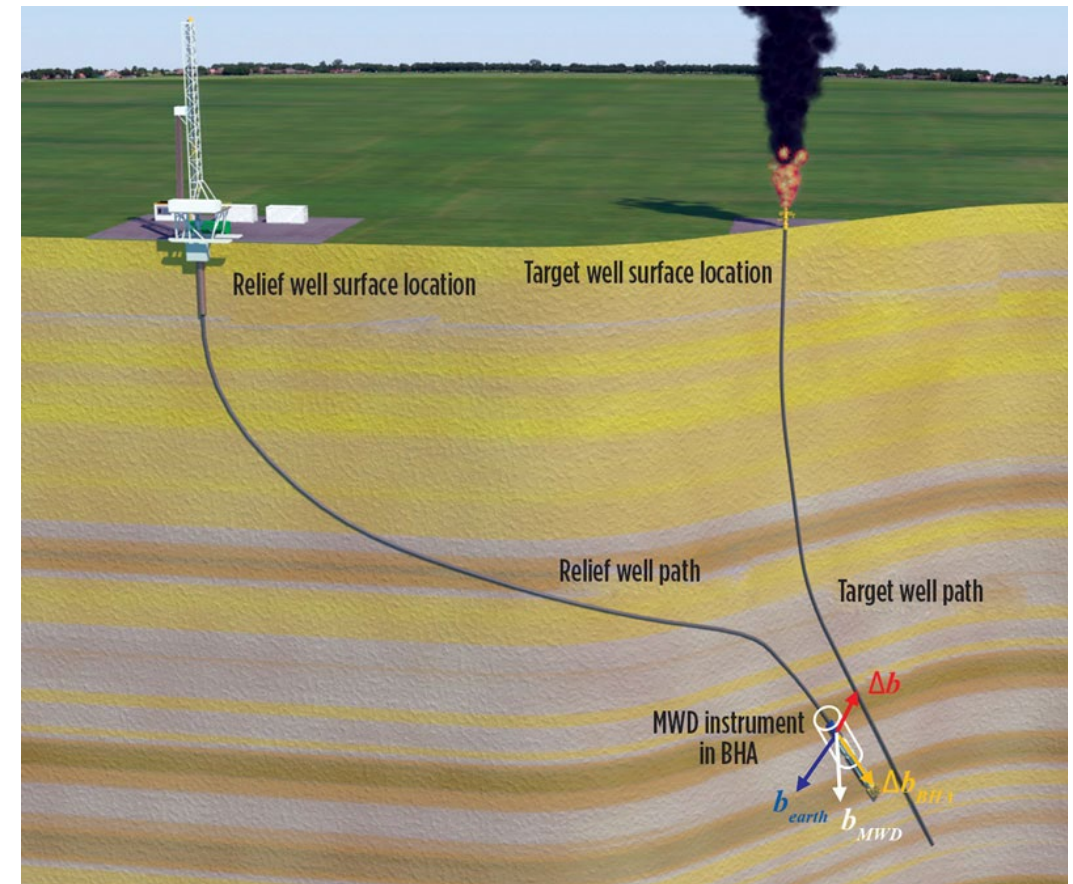

From Roggeband et al., 2020. Passive-magnetic ranging capability for relief wells in salt formations. World Oil, Vol 12, n241.



External data can help determine whether variations observed are due to instrument error or are external field changes – proximity of the external sensor is important – magnetic observatories in the US or Canada are not always close to production basins

- Data can be used to determine go/no go for drilling operation.
- Data can also be used for correcting the data from the drilling tool.

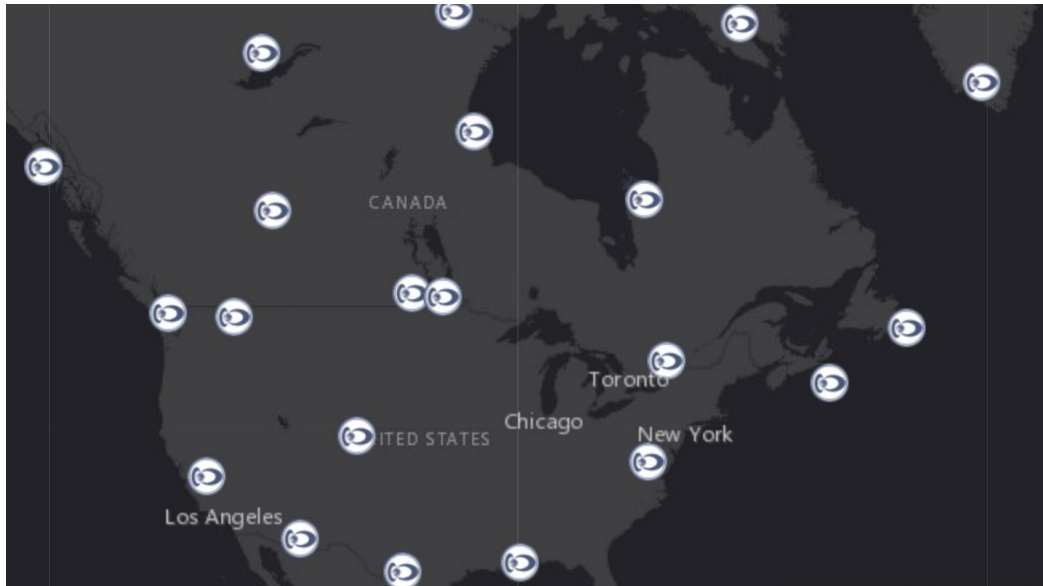

The use of fluxgate magnetometers for Space Weather monitoring

# MagStar



MagStar network managed by  
Computational Physics Inc (CPI)  
Image courtesy of CPI.  
Map of Intermagnet observatory

**GMW** Associates

# Next step with the system

**GMW***Associates*

## Presented by:

Ludo Letourneur  
Senior Sales Engineer  
GMW Associates  
ludo@gmw.com

# Magnetic data used to monitor the space weather data are fed into models of network and conductivity to provide prediction of GIC amplitude.

- An additional set of data would be to provide directly a reading of the current on transformer ground
- Clip-on and slip-on design allow for easy retrofitting onto conductors.
- Hall-effect CT

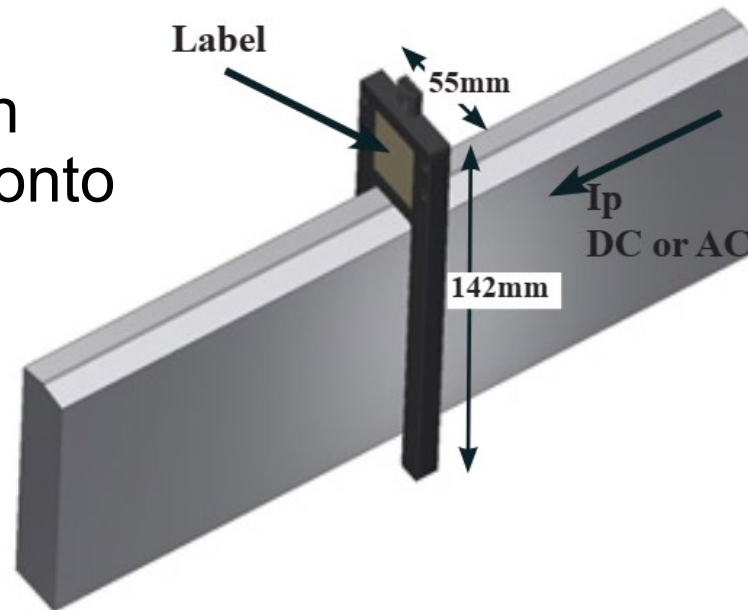

Slip-on and clip-on GMW current transducers. DC operation.



# Questions?

Please enter any questions into the chat box, thank you!



**Ludovic Letourneur, PhD**  
[ludo@gmw.com](mailto:ludo@gmw.com)  
Senior Applications Engineer  
GMW Associates



**Jenn Gannon, PhD**  
[gannon@cpi.com](mailto:gannon@cpi.com)  
GMD Lead  
Computational Physics, Inc.



**Mike Henderson**  
[mphend@gicmagnetics.com](mailto:mphend@gicmagnetics.com)  
Owner and Principal Engineer  
GIC Magnetics