

Bodo's Power Systems®

Next-Generation Current Probes for High-Speed and High Power-Density Applications

Clip-on Rogowski current probes provide a convenient and accurate means of measuring alternating currents. The latest wideband probes use an innovative shielding technique to eliminate the effects of high electrostatic field strengths in today's high power-density and high-speed circuits.

By Dr Chris Hewson, Power Electronic Measurements Ltd

Rogowski Probes: The Current State of the Art

Engineers involved in power electronics often use Rogowski current probes for measuring complex current waveforms. The probe comprises a thin, flexible, clip-around coil connected by a low-noise cable to an electronic integrator. The integrator plugs directly into a wide variety of recording devices, most typically an oscilloscope but also data acquisition systems and power, network, or spectrum analysers.

The coil is clipped around the conductor carrying the current to be measured. The coil measures the rate of change of current and the electronic integrator produces a voltage output proportional to the current. Although DC measurements are not possible, because the Rogowski coil measures di/dt , the probe offers many advantages to the power electronics engineer:

- Virtually zero insertion impedance (<10pH)
- The small probe head can be inserted into difficult to reach parts of a circuit thereby saving engineers adding flying leads, which corrupt circuit performance. A typical application is shown in figure 1.
- A wide-bandwidth from a few Hz to 30MHz
- High slew-rate capability of up to 70A/ns
- Isolated measurement
- High peak current ratings from 30A to 6kA (or more), maintaining the same small coil size throughout the current range.
- Measure small AC currents in the presence of large DC current

New Challenges

Recent developments in power converters and devices present new challenges to the use of Rogowski probes. Power converters such as UPS circuits, SMPS and Variable-Speed Drive (VSD) inverters are

becoming smaller for a given power rating. This increase in power density increases the field strength inside the converter, creating a more hostile environment for a current probe. In addition, silicon carbide (SiC) semiconductors, which combine faster switching times and higher blocking voltages than previous devices, are becoming common. Thus Rogowski probes must have a higher bandwidth and better common mode immunity (rejection of external fields) to accurately measure current in these devices.

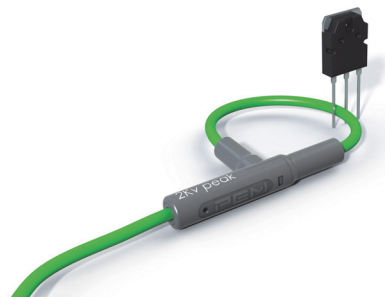

Figure 1: A CWT Mini coil, insulation voltage 2kV peak, thickness 3.5mm, coil length 100mm, threaded through the legs of a TO-247 semi-conductor package.

The latest generation of Rogowski current probes are able to overcome the problem of interference from local dV/dt transients, and yet maintain a small size and 30MHz bandwidth. To understand how this is achieved, it is necessary first to examine the effect of high electrostatic fields on a conventional Rogowski current probe.

Typically, a Rogowski coil comprises a solenoidal copper winding on a flexible plastic core. The output voltage from the coil is proportional to the turns density of the winding, N , and its cross-section area, A . The end of the solenoidal winding may be returned along the axial centre to form a cancelling turn, to prevent unwanted interference from conductors outside the coil loop.

Unlike other current probes using magnetic formers such as Hall-effect sensors or current transformers the Rogowski coil does not concentrate the flux produced by the current-carrying conductor around which the coil is looped. Thus the signal produced by the Rogowski coil is small and more susceptible to interference from external fields. In particular large local voltage transients (dV/dt) can cause interference on the Rogowski measurement through capacitive coupling onto the coil winding.

The schematic in figure 2 shows the essential elements of a Rogowski probe and the mechanism by which local voltage transients cause an error at the output of the probe. The Rogowski coil can be approximated to an inductance L (determined by the winding parameters A and N), a capacitance C (determined by the plastic material of the former and the distance between the axial return conductor and the winding), and the copper winding resistance, R . A disturbance voltage dV_x/dt causes a displacement current I_x which flows onto the coil winding via local stray capacitance C_x . The current I_x and the coil impedance produce an interference voltage at the output of the coil. This voltage is ultimately integrated to produce V_{error} at the output of the probe.

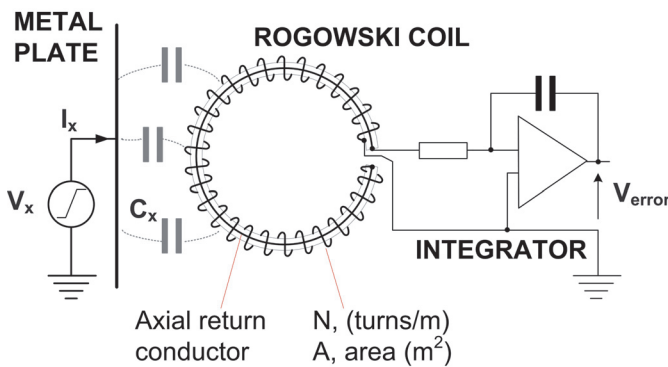

Figure 2: Schematic showing the Rogowski coil with a winding N (turns/m) and cross-section A (m^2). The output is connected to a high gain integrator

Screening the Probe

Fitting a screen (or shield) over the top of the Rogowski coil winding appears to offer a solution by providing a low-impedance path to ground allowing the displacement current to avoid the high-gain electronic integrator, resulting in lower V_{error} . However this simple solution has a problem, since the coil impedance has an appreciable effect on the high-frequency performance $f_{HF}(-3dB)$ where,

$$f_{HF(-3dB)} \propto 1/\sqrt{LC}$$

Fitting a screen will significantly increase the overall capacitance as there is additional capacitance between the coil winding and the screen. This will reduce the high-frequency bandwidth $f_{HF}(-3dB)$, compromising the probe's main function, which is to measure fast current waveforms.

Power Electronic Measurements Ltd (PEM UK) has developed an alternative technique for producing a small, screened, wide-band Rogowski probe, which significantly improves its rejection of common-mode interference. Instead of using an axial return conductor, the coil is inverted allowing the return conductor to be implemented as a thin copper screen on the outside of the coil winding. This presents a low-impedance path to ground for I_x significantly attenuating V_{error} . High-frequency performance is also improved, since any capacitances other than those between coil and screen are eliminated. Fitting another screen tightly over the top of the return conductor only marginally increases coil thickness and has no effect on bandwidth, yet significantly increases electrostatic field rejection.

High-frequency performance is also improved by reducing the winding density and hence the coil inductance, L . Because the inductance of the coil and the coil output voltage are interdependent, the gain of the

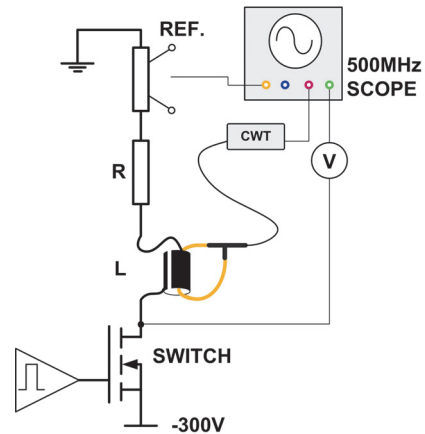

Figure 3a: Switching circuit to test the common-mode rejection of the CWT Mini

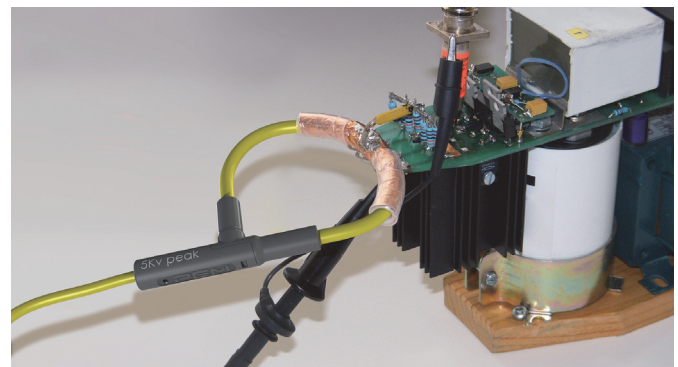

Figure 3b: Actual test circuit showing the coil in the tight fitting copper tube

Sensitivity (V/A) [Peak current (A)]	Noise (mVp-p)	Low frequency (-3dB) (Hz)	High frequency (-3dB) (MHz)
0.1 [60]	15.0	100	30
0.01 [600]	15.0	10	30

Table 1: Example performance of a screened small Rogowski probe

integrator must be increased to resolve small currents. This has in the past led to an unacceptable SNR at low frequency. However through improvements in integrator design and op-amp performance, using a combination of active and passive integration, it is possible to achieve example performance as summarised in table 1.

The ability of the coil to reject local dV/dt transients has been demonstrated using the test circuit shown in figure 3a, which replicates a single inverter leg. The circuit comprises four parallel superjunction MOSFETs with less than 15ns turn on time. The reference measurement is a DC-to-2GHz co-axial shunt. A tight-fitting copper tube, covering at least one third of the coil circumference, is added to increase the capacitive coupling between the coil and the dV/dt transient, so as to make this a 'worst case' measurement.

Figure 4 compares the response of the reference shunt and a CWTMini/03/B/1/100M/2 shielded Rogowski probe to a 2.5A, 1.2µs test pulse with a rise-time of 12ns. The waveforms are almost identical, showing that even with a 20V/ns transient close coupled to the Rogowski coil there is no visible interference on the 2.5A current waveform.

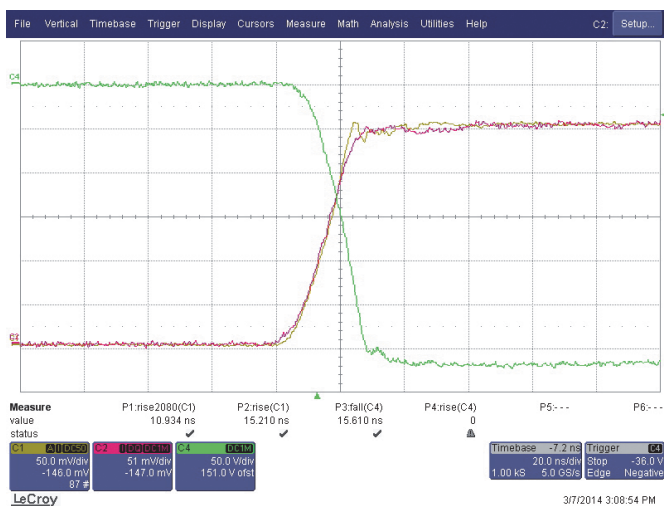



Figure 4: Comparison of reference and Rogowski probe measurements. Time base 20ns/div C2 - CWTMini/03 (Note the waveforms include 16.8ns de-skewing to eliminate the inherent yet predictable delay of the Rogowski current transducer. This delay is the sum of delay in the Rogowski coil, the connecting cable and the integrator)

The result of the experiment demonstrates the probe's ability to measure rapidly changing current with high accuracy, which is particularly useful when measuring device switching loss.

www.pemuk.com

CWT wide-band AC current probes



- Thin, flexible, clip-around ac current probes
- Wide-band from below 0.01Hz to greater than 20MHz (-3dB)
- Ideal for power electronics development work
- Current ratings 30A to 600kA

CWT Mini



- Two miniature coil sizes (3.5mm or 4.5mm) up to 200mm length
- Insulation voltage 2kV or 5kV peak

CWT Ultra-mini



- Coil size (max 1.7mm cross-section), 80mm length
- Insulation voltage 1.2kV peak

CWT LF



- Extended low-frequency cut-off
- Available with standard or mini coil

Please contact us to discuss your application



Power Electronic Measurements



Tel: +44 (0)115 946 9657 www.pemuk.com