



User's Manual

# BIPOLAR POWER SUPPLY

## BPS 85-70

## BPS 40-100

rev E, April 2021  
ID: 180323PH



---

**TABLE OF CONTENT**

<b>1 WARNINGS AND CAUTIONS .....</b>	<b>5</b>
1.1 Explanation of symbols shown in BPS or in this Manual.....	6
1.2 Package content .....	6
<b>2 OVERVIEW .....</b>	<b>7</b>
2.1 Introduction .....	7
2.2 Environmental Requirements.....	8
2.3 Power Input.....	8
<b>3 INSTALLATION .....</b>	<b>9</b>
3.1 Unpacking.....	9
3.2 Positioning BPS .....	10
3.2.1 Installing BPS into device rack .....	10
3.2.2 Rack Slides .....	10
3.3 Installing the power interface .....	11
3.3.1 Selecting Input Voltage.....	12
3.3.2 AC input connectors .....	12
3.3.3 Installing 3-phase input cable .....	13
3.3.4 Connecting Power Output.....	15
3.4 Control interface.....	16
3.4.1 Connectors.....	16
<b>4 OPERATION: LOCAL MODE .....</b>	<b>17</b>
4.1 Explanation of Controls .....	17
4.2 Display and its menus .....	18
4.2.1 Home menu .....	18
4.2.2 Fault Flag and Status Menu.....	19
4.2.3 Status Menu.....	19
4.2.4 Tuning Menu.....	20
4.3 Operation: .....	22
4.3.1 Operation of Current and Voltage limits: .....	22
4.3.2 Setting Current and Voltage limits: .....	22
4.3.3 Enabling and Disabling .....	22
4.4 Tuning BPS to load in Local Mode .....	23
4.4.1 Tuning in Current and Local Mode .....	23
4.4.2 Tuning in Voltage and Local Mode .....	24
<b>5 OPERATION: REMOTE MODE .....</b>	<b>25</b>
5.1 Computer Control.....	25
5.2 Tuning BPS to load in Remote Mode .....	25
5.2.1 Tuning in Current and Remote Mode .....	26
5.2.2 Tuning in Voltage and Remote Mode .....	28
5.2.3 Tuning in Parallel operation Remote Mode .....	28
<b>6 PARALLEL OPERATION .....</b>	<b>29</b>
6.1 Connections .....	29
6.1.1 3-phase Mains voltage connection .....	30
6.1.2 Power output connection .....	30
6.1.3 Parallel cable .....	30
6.1.4 CONTROL cable.....	30
6.1.5 INTERLOCK .....	30
6.2 Operation .....	30
6.3 Calibration.....	31
6.3.1 Local Current mode .....	32
6.3.2 Remote Current mode .....	32
6.3.3 Local Voltage mode .....	32

---

6.3.4 Remote Voltage mode .....	33
6.3.5 Parallel Mode .....	33
<b>7 MAINTENANCE .....</b>	<b>34</b>
7.1 Preventive Maintenance .....	35
7.2 Troubleshooting.....	36
<b>8 SPECIFICATIONS .....</b>	<b>39</b>
8.1 Features .....	39
8.2 Output performance.....	39
8.2.1 Voltage mode: .....	39
8.2.2 Current Mode: .....	40
8.3 Control and monitoring .....	40
8.4 System specifications .....	41
8.5 Environmental requirements:.....	41
8.6 Regulatory .....	41
<b>APPENDIX1: CONTROL INTERFACE PIN-OUT.....</b>	<b>42</b>
<b>9 WARRANTY AND LIABILITY .....</b>	<b>47</b>

---

## REVISION HISTORY

Author	Name	Title	Date
Written by	Pasi Honkanen	Product Manager	23.3.2018
Reviewed by	Rauno Aaltonen	Technical director	26.3.2018
Approved by	Kimmo Alho	President	26.3.2018

Revision	Chapter	Description	Date/Name
A		First version, draft. Only for BPS revision 0.1	23.3.2018 PH
B		0-series version. Corrections	1.11.2018 PH
C		Cautions about load energy. Interface schematics	19.11.2018 PH
D		Load Energy Control, Corrections	6.2.2020 PH
E		BPS-40-100 merged	28.4.2021 VI

## PROPRIETARY NOTICE

© 2021 Oy International Electric Company, Helsinki, Finland. All rights reserved. Reproduction of any part without the written permission of Oy International Electric Company is prohibited.

This document contains proprietary and copyrighted information and is intended for the exclusive use of Oy International Electric Company customers.

Copying, disclosure or other use is strictly prohibited without the express written authorization of Oy International Electric Company. Report any violations to Oy International Electric Company.

Oy International Electric Company reserves the right to make changes to any specifications shown herein at any time without notice or obligation. All specifications are for information only.

Address inquiries regarding this document or the device described herein to the manufacturer:

### Oy International Electric Company

Sahaajankatu 48  
00880 Helsinki  
Finland

Email: [info@ieco.fi](mailto:info@ieco.fi)  
Internet: [www.ieco.fi](http://www.ieco.fi)

---

## 1 WARNINGS AND CAUTIONS

The BPS 85-70 or BPS 100-40 Bipolar Power Supply (later “BPS”) is designed and manufactured according to the International Standard IEC61010 for electrical equipment. Use caution when accessing, handling, testing, connecting or servicing BPS. Carefully study the following paragraphs.

- If the equipment is used in a manner not specified by the manufacturer, the protection provided by the equipment may be impaired.
- Use against instructions is prohibited.
- Before applying power to the load, verify that the BPS is configured properly for your particular application. See Chapters: “Tuning BPS to load in local mode”, “Tuning BPS to load in remote mode”.
- Performing of installation, operation, or maintenance procedures other than those described in this manual may result in a hazardous situation and may void the manufacturer’s warranty.
- All national regulations and laws concerning assembly and installation work must be followed.
- Ensure that the personnel using BPS are instructed in the proper usage and care, are aware of performance limitations and are aware of and observe all warnings and cautions described in this manual.
- Only *qualified personnel* who deal with attendant hazards in power supplies, are allowed to perform installation and servicing.
- Handle BPS with care when transporting. BPS must not be subject to strong shocks, forces, or vibration as they may damage BPS.
- Ensure safe access to BPS and its ventilation by positioning BPS so that the front and rear sides are at least 80 cm from the nearest device or wall. Possible back wall/door in device rack should be perforated.
- Do not cover BPS’s front cover’s perforation or rear fans to prevent proper cooling.
- BPS must not be installed or stored in upright position i.e. front cover upward. Rear connectors could be damaged.
- Observe all (yellow) warning labels in BPS.
- Never remove warning labels from BPS.
- Do not use BPS if there are any signs of external damage, or if any parts are damp or wet.
- Do not place anything liquid over BPS.
- Do not measure or adjust BPS with the power on unless another person is present.
- Be aware of the high voltage present on the rear connections.
- Never put any object through BPS’s front cover’s or back cover’s perforation.
- High voltages hazardous to human safety may be generated on the output terminals. The customer/user must ensure that the output power lines are labelled properly as to the safety hazards and that any inadvertent contact with hazardous voltages is eliminated.
- BPS’s electronics are sensitive to electrostatic discharges (ESD). Do not touch any of the BPS’s electronics or sockets as ESD may damage BPS.
- Always keep BPS’s top cover closed when BPS is powered. Only qualified service personnel should open the top cover.
- If the top cover needs to be opened, keep the BPS’s 3-phase input cable unplugged for 5 minutes before opening the top cover. This operation is restricted to qualified personnel only and it must be noted that there are hazardous voltages in the units inside BPS. Even if the power is off, capacitors may retain an electrical charge. Guard against risks of electrical shock during open top cover checks by not touching any portion of the electrical circuits. Use safety glasses and hearing protection during open cover checks and troubleshooting to avoid personal injury by any sudden component failure.

- To reduce risk of fire or electrical shock, install BPS in a temperature and humidity controlled indoor area, free of conductive contaminants.
- Neither Oy International Electric Company, Helsinki, Finland, nor any of its sales distributors can accept any responsibility for personnel, material or consequential injury, loss or damage that results from improper use of BPS and accessories.
- BPS weighs 55 kg (121 lb.) and may have sharp edges. Never try to lift BPS without help. BPS is equipped with lifting eyes, see chapter “Unpacking”. Always use safety shoes and cut resistant work gloves when lifting or moving BPS.
- BPS is delivered as stand-alone item and designing possible rack installation is under customer’s responsibility. When installing the BPS into a 19 Inch Rack, the customer is responsible for ensuring that the rack is properly secured to prevent inadvertent tipping. The BPS is 55kg (121 lb.) and particularly when the BPS is mounted using rack slides it may be possible, if rack installation is not properly designed and secured by the customer, that when the BPS is extended out of the rack e.g. on its slides the rack may become over-balanced and tip.

## 1.1 Explanation of symbols shown in BPS or in this Manual

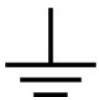

Functional Earth



Warning, see manual



Protective Earth (PE)



Warning, danger of electric shock



Note; important information to be noted

## 1.2 Package content

In addition to BPS, the package includes:

- 4-quadrant output Mains connector: Phoenix PC 5/5-STF1-7,62 – 1777862
- Mains cable’s strain relief
- Mains cable’s strain relief’s locking nut
- Strain relieves, two sizes
- Cable ties for strain relieves
- Mains connector enclosure
- Mains connector enclosure’s bottom
- Dummy Control connector
- Dummy Master-Slave connector
- Dummy Interface connector
- Screws for rack slides
- Pads under the BPS for table use

## 2 OVERVIEW

### 2.1 Introduction

BPS Bipolar Power Supply is a general-purpose power supply with following characteristics:

- High performance bipolar power supply with
  - $\pm 85$  V,  $\pm 70$  A output for BPS-85-70
  - $\pm 40$  V,  $\pm 100$  A output for BPS-40-100
- 4-quadrant output operation
- Voltage mode and current mode
- Parallel operation for
  - $\pm 85$  V,  $\pm 140$  A output for BPS-85-70
- Very low switching ripple and noise
- Flux gate current transducer for excellent temperature and long-term current stability
- Ramp response for different loads tuned from front panel
- Analogue voltage programming of output voltage or current
- Air cooled, 19 " rack mountable package (5 U), 55 kg (121 lb)

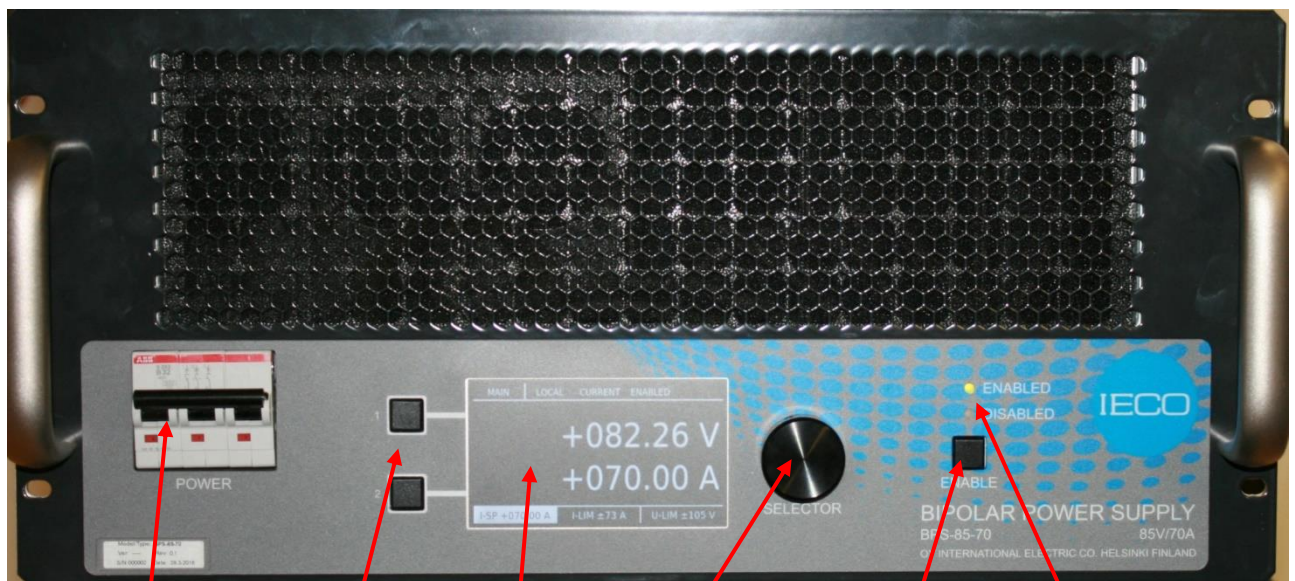

Circuit Breaker

Buttons 1&2

Display

Selector

Enable button

LEDs

**Figure 1: BPS Front**

## 2.2 Environmental Requirements

BPS is intended for indoor use only, max 2000m above sea level. Environmental temperature range is 10 to 40°C and relative humidity 30 to 70%, non-condensing. Install BPS in a temperature and humidity controlled indoor area, free of conductive contaminants. Pollution degree: 2.

## 2.3 Power Input

Input voltage:

BPS supports two mains voltages:

HI: 3x 324V-457VAC 47-63Hz L1, L2, L3 and N (N must be connected!). Phase-to-N voltage: 187-264VAC (Figure 2).

LO: 3 x 187-264VAC 47-63Hz L1, L2, L3, no N (Figure 3).

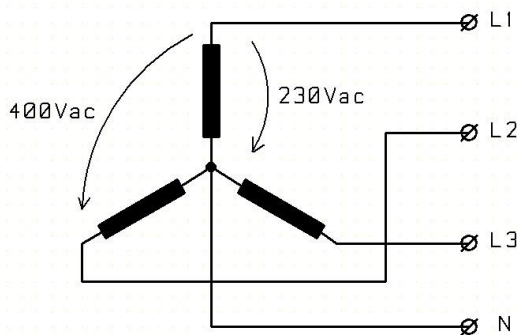

**Figure 2.** EU network with N (HI)

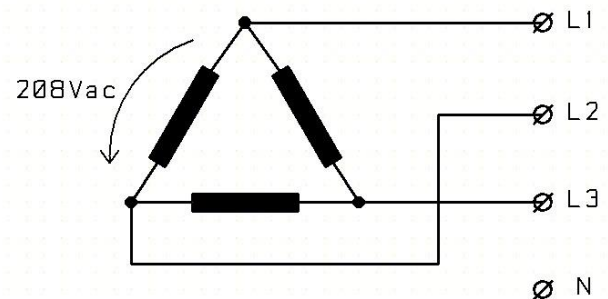

**Figure 3.** US network, no N (LO)

Proper input voltage is selected by Voltage Selection Switch at rear panel. See figure 6.

Input current: max 30A per phase.

Idle power losses: 500W.

Internal capacitor bank: 36mF.



## 3 INSTALLATION



### WARNING

*Only properly trained and qualified personnel may install or service BPS. Local safety regulations or laws must be followed to ensure the safety of the people working with BPS and that no damage is caused to BPS or any other equipment or property. These instructions are provided only as a reference. The qualified electrician is required to familiarize itself with these instructions before starting to work with BPS.*

**Customer is responsible that power feeding for BPS is installed according to local safety regulations. External mains switch (e.g. according to 60947-1 or 60947-3) for the BPS must be installed by the customer to switch AC power from mains outlet.**

*Always be sure that the AC power cable from mains outlet is unplugged and mains switch is switched off before servicing or installing parts to the equipment.*

*All protection earth (PE) connections must be connected from both ends before operation.*

### 3.1 Unpacking



### WARNING

*Heavy Unit. BPS weighs 55kg. Never try to lift BPS without help.  
Use special care when using lifting eyes and ensure that lifting eyes have been installed properly in their holes.*

Please note that the instructions below are only guidelines and that the customer is responsible for planning its own unpacking procedures to ensure safety and that no damage is occurring to the BPS or any property or personnel.

Lifting BPS should be done by using lifting eyes.

Lifting eyes will be screwed to holes at BPS's top cover.

If the lifting eyes are not already at BPS's top cover, they are located at rear of BPS. See Figure 5.

Lifting eyes can be removed and placed at back of BPS after use.



**Figure 4:** Lifting eyes at roof of BPS

---

## 3.2 Positioning BPS



### WARNING

*Customer has to ensure that possible installation to a device rack conforms to safety requirements.*

*BPS is delivered as stand-alone item and designing possible rack installation is under customer's responsibility. When installing the BPS into a 19 Inch Rack, the customer is responsible for ensuring that the rack is properly secured to prevent inadvertent tipping. The BPS is 55kg (121 lb.) and particularly when the BPS is mounted using rack slides it may be possible, if rack installation is not properly designed and secured by the customer, that when the BPS is extended out of the rack e.g. on its slides the rack may become over-balanced and tip.*

BPS can be used in table or in device rack.

There are pads under BPS for table use. Pads are included in package.

### 3.2.1 Installing BPS into device rack

Remove the pads under BPS with screwdriver if the pads were installed.

Use special care when lifting BPS into device rack.

Do not fasten BPS only by using the front panel's holes. Use appropriate rack angles or optional slides to support BPS.

Ensure that rack has adequate ventilation

### 3.2.2 Rack Slides

BPS can be mounted to 19" rack frame by rack slides. M4 holes for rack slides are at sides of BPS. Use only appropriate slides. M4x8 screws for fastening the rack slides are included in package.

### 3.3 Installing the power interface

Places for lifting eyes after lifting is done.

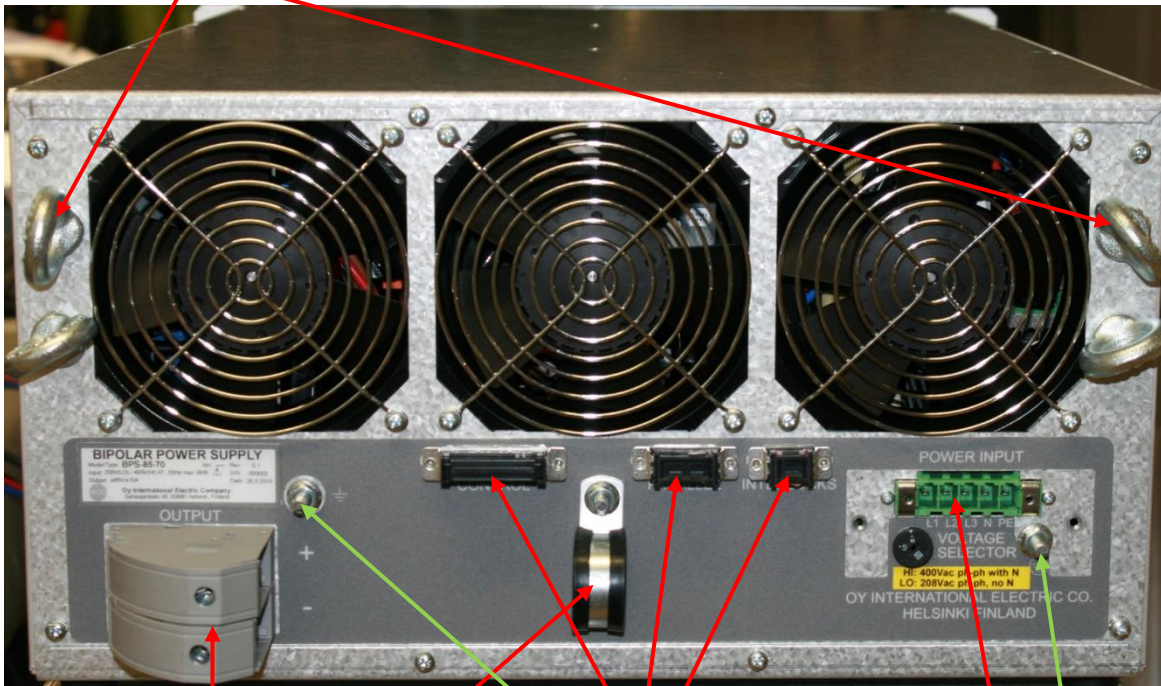

Output connectors

Strain relief  
for output cables

Control Interface

Power input  
Note: Cover removed

**Figure 5:** BPS back.

Additional ground stud

Protective Earth PE

### 3.3.1 Selecting Input Voltage



## CAUTION

*Set the Voltage Selector Switch to proper position before connecting Power Input Connector.*

3-phase mains input voltage selection is done by Voltage Selector Switch. Voltage Selector Switch must be turned to correct position according to markings:

HI: 3x 324V-457VAC 47-63Hz L1, L2, L3 and N (N must be connected!). Phase-to-N voltage: 187-264VAC (Figure 2).

LO: 3 x 187-264VAC 47-63Hz L1, L2, L3, no N (Figure 3).

See Figures 2 and 3 for reference.

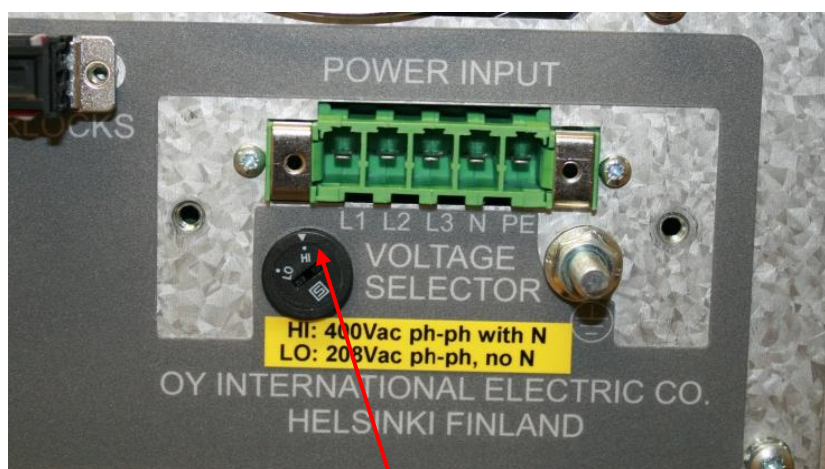

**Figure 6.** Voltage selector in HI-position.

Small arrow at top of voltage selector switch shows the position of the switch.



## CAUTION

*Incorrect Voltage Selector Switch position may result in damage to BPS.*

### 3.3.2 AC input connectors

**L1, L2, L3, N, PE**, AC-input. N is not used in Delta network.  
Terminal type: Phoenix DFK-PC 5/ 5-ST-7,62 - 1716535.

Mating connector for AC-input: Phoenix PC 5/5-STF1-7,62 – 1777862.  
Mating connector provided in package.

**Protective Earth (PE)**, M6 stud.

Always use adequate and unambiguous markings in cables to prevent incorrect connection.

Maximum conductor cross section is 6mm<sup>2</sup> (10 AWG). Select adequate cross section for actual input current.

Tightening torque 0.7 – 0.8 Nm (0.5 – 0.6 lbt·ft).

### 3.3.3 Installing 3-phase input cable



## WARNING

*Make sure that 3-phase input cable is unplugged from Mains outlet before any operation.*

*If fixed wall connection, turn off the switch from outlet and breaker from power panel.*

3-phase input has metallic protective cover and a strain relief part, see Figure 7.

1. Remove the metallic cover from power input by two screws. Metallic cover is possibly already removed from BPS and it is included in package.
2. Metallic cover has 2 alternatives for cable entry. Select the most suitable entry. Note that the seal and strain relief can be changed and cover can be turned 180 degrees to allow access from side of BPS.

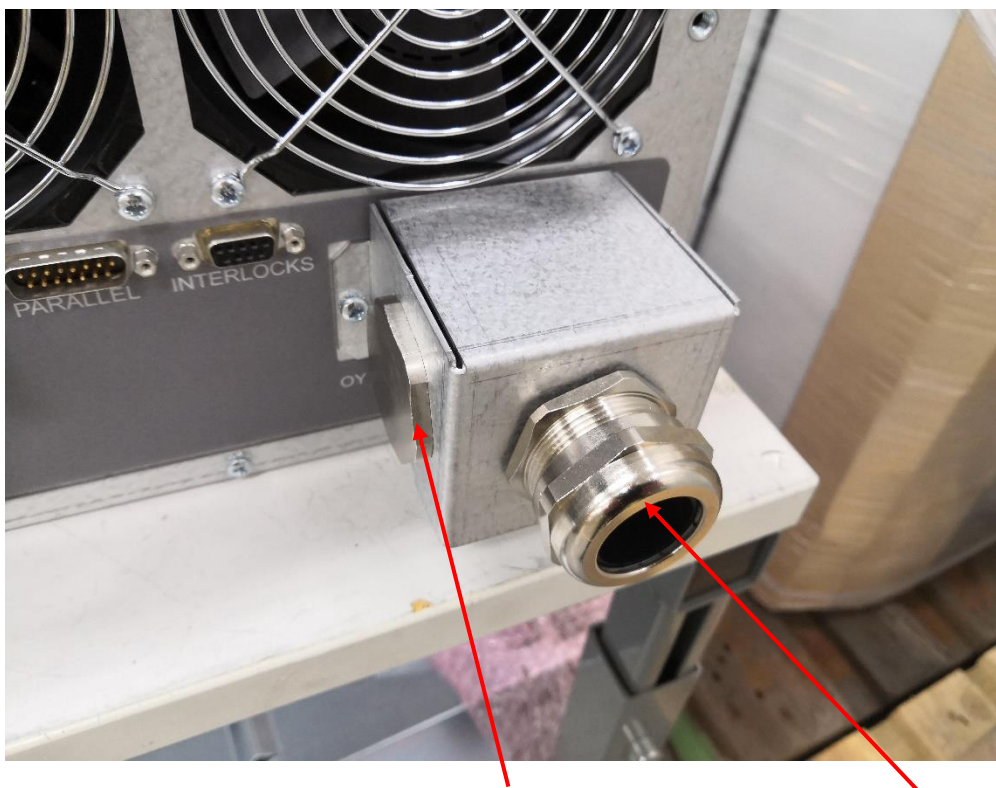

**Figure 7:** Metallic cover installed.      Sealed optional entry      Selected entry

3. Unscrew the strain relief's outer part and thread the input cable through it.
4. Place the strain relief to metallic cover and fasten its inner part inside the metallic cover. Tighten the strain relief.
5. Remove the input mating connector and connect the 3-phase input wires according to markings to it (Figure 8).
6. Connect the input connector to BPS's power input and fasten it by two screws (Figure 8).
7. Fasten the metallic cover to its place with two screws (Figure 9).

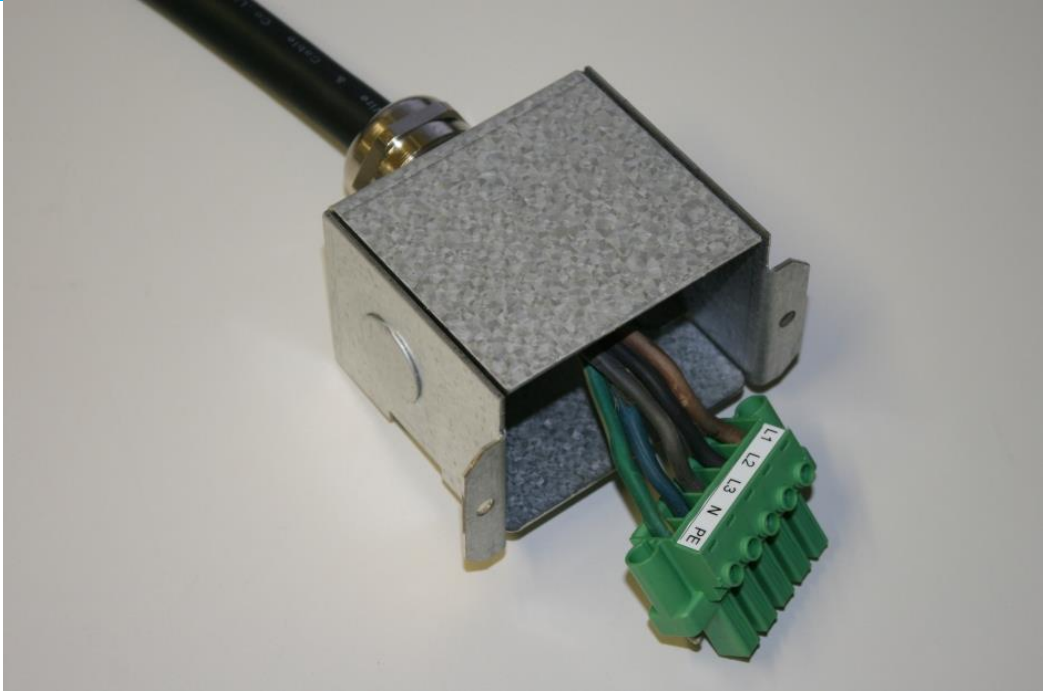

**Figure 8.** Metallic cover with strain relief and input mating connector. Note that cover in image is slightly different from current one.

For proper cabling, outer black insulation protecting 5 wires inside should be cut first by 90mm. Then strip the 5 cables' insulation by 10mm.



**Figure 9:** Tightening the input mating connector to BPS. Metallic cover's fastening

### 3.3.4 Connecting Power Output

Terminal type: Phoenix Contact RWV-8.

M8 cable shoe connection.

Tightening torque 4.5 – 5Nm (3.3 – 3.7 lbt-ft).

Conductor cross section is 6 mm<sup>2</sup> - 35mm<sup>2</sup> (2 – 10 AWG). Select adequate cross section for desired output current.

*Always use adequate and unambiguous markings in cables to prevent incorrect connection. Be careful not to drop the fastening nuts of output connector.*

1. Unscrew the screws of output connector and open its cover, see Figure 10.
2. Thread the output cables through the strain relief. There are two sizes of strain relieves in package. Select the suitable one for selected output cables.
3. Connect the output cables according to markings.
4. If the cable is shielded, the shield should be connected to additional ground stud, see figure
5. If the load has a ground lead, connect it to ground stud.
5. Close the cover of output connector and tighten the screws
6. Use the cable ties to fix the cables to strain relief if needed.



**Figure 10:** Output terminal and cables. Cable tie is not shown in picture.

## 3.4 Control interface

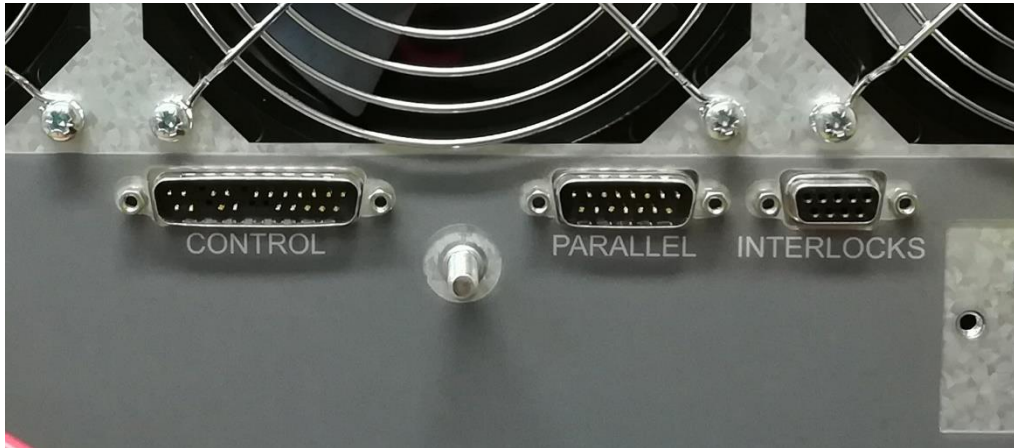

**Figure 11:** Control connectors. Note that strain relief is not in its place in picture.

### 3.4.1 Connectors

#### CONTROL

“Control” connector includes all signals that are needed to operate BPS in Remote mode. Use dummy plug if Remote mode is not used (dummy plug is connected to this connector by default).



Note; When dummy plug is connected to Control connector, BPS is automatically in “Local Mode”. See chapter “Local Mode”. Dummy plug bypasses the Interlock in Control connector’s pins 23&24 (see APPENDIX1)

#### PARALLEL

Parallel connection is needed when two BPS are used in Parallel mode. Use dummy plug if parallel operation is not used (dummy plug is connected to “parallel” connector by default).

#### INTERLOCKS

“Interlocks” connector includes 2 separate interlocks inputs. Use floating closed contact switch to provide interlock signal. Open contact disables BPS. BPS needs reset-signal (in “Control” connector) to operate after interlock has recovered.

Dummy plug is needed in parallel mode on Slave unit, system must be always be protected by interlocks which are connected to Master BPSs “Interlock” connector.

Control cables could be fastened to strain relief with cable ties.

Pin-out information regarding Control, Interlocks and Parallel interfaces, refer to **APPENDIX1**.



Note: Always connect only correct signals into corresponding connectors.



## 4 OPERATION: LOCAL MODE

BPS is in Local mode by default if the Remote input -pin is not connected to D25 Control connector, see chapter: Control Interface.

To operate in Local mode, use dummy plug in CONTROL and PARALLEL connectors.

INTERLOCK connector should have protective interlocks in use.

In Local Mode, BPS is disabled by default when powered up. For supplying output, enable button should be pressed.

### 4.1 Explanation of Controls

In Local Mode BPS is controlled by Buttons and Selector. User selects current or voltage mode, enables BPS and sets the current/voltage setpoint.

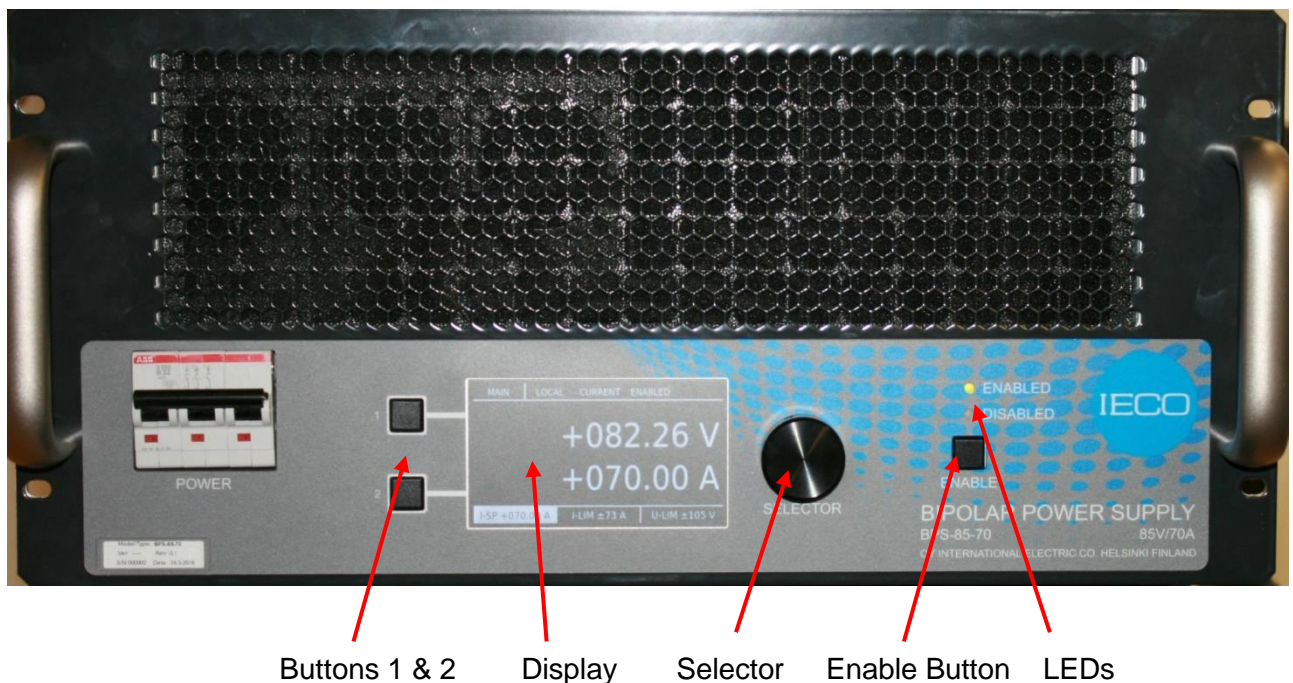

**Figure 12:** BPS controls.

Explanation of controls:

Buttons 1 & 2	When Buttons 1 or 2 are active, there will be text in display next to Button showing the function. Function of the Button is different in different menus.
Display	Shows actual output current and voltage and other information, see chapter "Display and its menus"
Selector	Selector is used for setting current and voltage setpoints, scrolling the menu and selecting/adjusting parameters. Pressing selector activates the parameter or changes fine/coarse steps in adjustment.
Enable Button	Enables BPS. Used only in Local Mode.
LEDs	Show if BPS is enabled or disabled. Work in Local and Remote Mode.

## 4.2 Display and its menus

### 4.2.1 Home menu

SW\_VER LOCAL/REMOTE CURRENT/VOLTAGE ENABLE/DISABLE

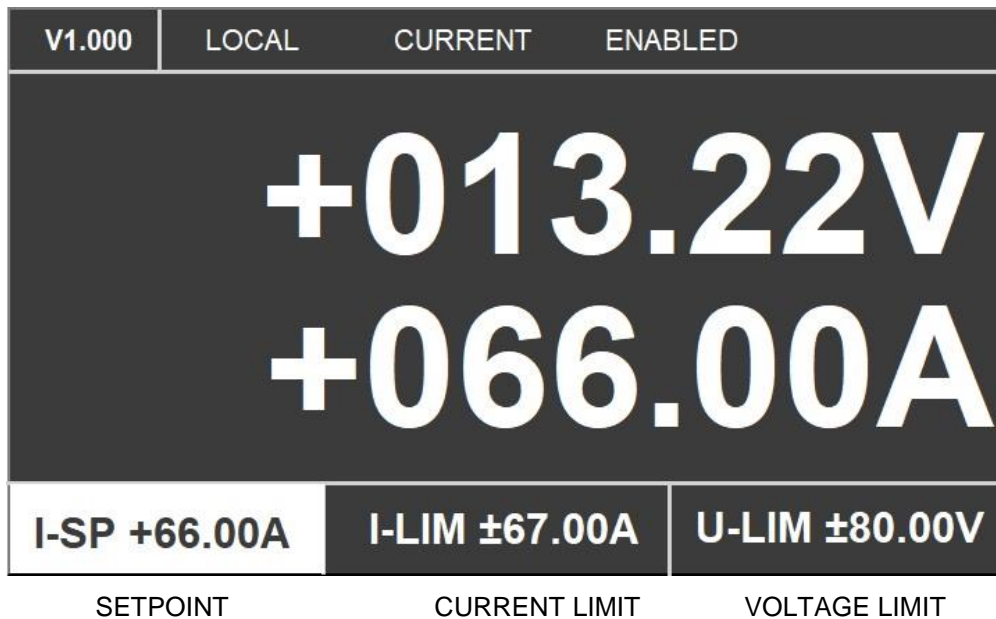

**Figure 13:** Home menu

#### MENU EXPLANATIONS:

SW_VER	Current SW-version
LOCAL/REMOTE	Mode: Local or Remote
CURRENT/VOLTAGE	Mode: Current or Voltage
ENABLED/DISABLED	Status: Enable or Disable output
FAULT	Fault present (not seen in Figure 13.)
SETPOINT	Current or Voltage Setpoint
CURRENT LIMIT	Current limit: Positive and Negative
VOLTAGE LIMIT	Voltage limit: Positive and Negative
CENTER:	Actual Voltage and Current value at output of BPS



CURRENT LIMIT AND VOLTAGE LIMIT background is red when active.

More information of current and voltage limits, see chapter: "Operation of Current and Voltage limits"



### CAUTION

**Always set the current and voltage limits to desired value before enabling BPS.**

## 4.2.2 Fault Flag and Status Menu

If there is a fault in BPS, a red fault flag appears next to Button2 in display. BPS output is disabled and there is no output power.

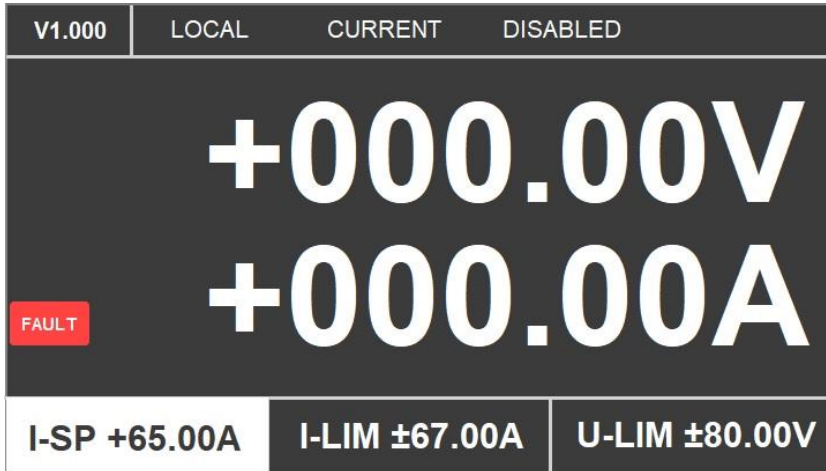
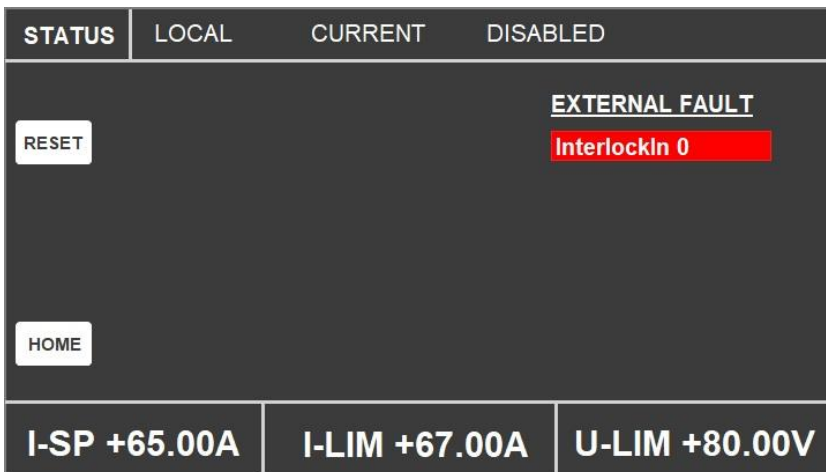

**Figure 14:** Fault flag

## 4.2.3 Status Menu

When Fault Flag appears, press Button2 to access Status menu.

In Status menu, only active faults are shown. E.g. in Figure15: InterlockIn0 has opened.



**Figure 15:** Status menu

Most of the faults are cleared by Reset button (Button1 in Display).

Check the source of the fault and correct it. Press Reset after correcting the fault.

After the fault is cleared, return to Home Menu by pressing the Home button (Button2 in Display).

See chapter “Troubleshooting” for detailed description of the faults.

## 4.2.4 Tuning Menu



### CAUTION

*Only qualified and properly trained personnel should use Tuning Menu.*

In tuning menu it is possible to:

- Select Current or Voltage Mode
- Set Current or Voltage Limits
- Tune BPS to load
- Configure Master/Slave/Single unit selection
- Calibrate offsets, gains and display readings

At Home Menu, Press Button1 (see Figure 12) for 5 seconds to access Tuning Menu.

TUNING	LOCAL	CURRENT	DISABLED
		<b>ULim</b>	<b>248</b>
<b>STORE</b>		<b>ILim</b>	<b>101</b>
		<b>Imode</b>	<b>1</b>
		<b>Ramp Limiter</b>	<b>174</b>
<b>HOME</b>		<b>L-Comp</b>	<b>0</b>
		<b>U-Comp</b>	<b>1023</b>
<b>I-SP +00.00A</b>		<b>I-LIM +67.00A</b>	<b>U-LIM +80.00V</b>

**Figure 15:** Tuning Menu.



More parameters can be seen by scrolling the Menu with the Selector.

#### MENU EXPLANATIONS

Ulim:	Voltage limit
ILim:	Current limit
IMode:	Current Mode = 1, Voltage Mode = 0
Ramp Limiter:	Increases ramp time of setpoint (only Current Mode)
L-Comp:	Load inductance compensation (only Current Mode)
U-Comp:	Output voltage compensation (only Current Mode)
IfbGain:	Current feedback gain (only Current Mode)
UfbGain:	Voltage feedback gain (only Voltage Mode)

Rest of the parameters are discussed in chapters: "Parallel Mode" and "Calibration".

Turn Selector (see Figure 12) to move in menu. Press Selector to activate the parameter. After activating the parameter, turn Selector to adjust the value. By pressing Selector again, fine/coarse step can be changed.

When parameter is changed, accept the new value by pressing ACCEPT (Button1) or cancel it by pressing CANCEL (Button2). CANCEL return previous value.

TUNING	LOCAL	CURRENT	DISABLED
ACCEPT		ULim	248
		ILim	101
		Imode	1
CANCEL		Ramp Limiter	574
		L-Comp	0
		U-Comp	1023
I-SP +65.00A		I-LIM +67.00A	U-LIM +80.00V

Figure 16: Setting a parameter.

When parameter is accepted it needs to be stored to EEPROM so it is still valid after power cycling.

Store the new value by pressing STORE (Button1) or go back to HOME menu (Button2).

STORE text has white background when STORE is not done yet and the old parameters will be valid when powered down and up.

STORE text has green background when STORE is pressed and new parameters will be valid when powered down and up.

TUNING	LOCAL	CURRENT	DISABLED
STORE		ULim	248
		ILim	101
		Imode	1
HOME		Ramp Limiter	574
		L-Comp	0
		U-Comp	1023
I-SP +00.00A		I-LIM +67.00A	U-LIM +80.00V

Figure 17: Storing a parameter.

## 4.3 Operation:



### CAUTION

*Ensure that all input and output connections have been connected, see chapter "Installation". See chapters "Tuning BPS to load in local mode", "Tuning BPS to load in remote mode" to ensure that parameters are right.*

1. Power on External Mains Switch to power BPS's power input.
2. Power up BPS by turning Circuit Breaker to on-position, see Figure1. Starting of BPS takes about 30 seconds.
3. If BPS shows faults, go to Fault Menu, check the source of the fault and clear the faults.

### 4.3.1 Operation of Current and Voltage limits:

Current limit operates typically when:

- a) Current limit is set to lower value than desired setpoint (local or remote) in current mode. In that case output current will stay in current limit level.
- b) BPS is in voltage mode and load resistance is smaller than:  
 $R = \text{Setpoint\_voltage} / \text{Current\_limit}$ . In that case current will stay in current limit level.

Voltage limit operates typically when:

- a) Voltage limit is set to lower value than desired setpoint (local or remote) in voltage mode. In that case output voltage will stay in current limit level.
- b) BPS is in current voltage mode, load is inductive and current is ramped up so fast that output voltage exceeds voltage limit with formula:  $V = L \cdot di/dt + I \cdot R$ . In that case output voltage will stay at voltage limit until the ramp is over.

### 4.3.2 Setting Current and Voltage limits:

1. Go to Tuning Menu.
2. Current limit: Scroll to ILim with Selector and press Selector. Turn selector to adjust desired Current limit. Current limit parameter has range of 0...1023 but actual  $\pm I$ -LIM value is seen at low part of display. By pressing Selector again, fine/coarse step can be changed.
3. Voltage limit: Scroll to ULim with Selector and press Selector. Turn selector to adjust desired Voltage limit. Voltage limit parameter has range of 0...1023 but actual  $\pm U$ -LIM value is seen at low part of display. By pressing Selector again, fine/coarse step can be changed.

Current and Voltage limits effect also in Remote Mode.

### 4.3.3 Enabling and Disabling



### CAUTION

*If load's energy is too high\*, output current shouldn't be ramped down too fast e.g. by disabling BPS at high load's energy. If load's energy is transferred too fast to BPS, it would then charge BPS capacitor bank too high and crowbar at output terminal will short circuit the output to protect BPS. Crowbar operation disables BPS and Crowbar fault is seen in display. Crowbar is reset by powering down BPS. Recovering of crowbar takes about 5 minutes.*



\* **Note:**  $E_{load} > 500J$  in single unit or  $> 1000J$  in parallel connection (BPS-85-70) or  $> 150J$  in single unit (BPS-40-100).



**Note:** BPS can be ordered with Energy Control option (EC). EC will slow down the current slope keeping the energy stored to BPS at safe level, which prevents crowbar triggering/operation.

#### 4.3.3.1 Enabling BPS

1. Press Enable button for enabling BPS.
2. Adjust the setpoint with Selector. Setpoint can be seen at bottom left corner of the display. Pressing Selector sets the active digit from 10mA to 500mA digit (10mV/500mV in Voltage Mode). Actual output current and voltage are updating at display. By pressing Selector again, fine/coarse step can be changed.

#### 4.3.3.2 Disabling BPS

1. When BPS is enabled, press Enable button for disabling BPS.
2. Note the Caution above. If load energy is too high without EC-option, current should be decreased before disabling.

## 4.4 Tuning BPS to load in Local Mode

In Local mode pre-selected parameters for different loads are used when running dc current/voltage. Proper parameters ensure optimal performance and prevent possible oscillation.

Set the suitable parameters for different modes and load.

### 4.4.1 Tuning in Current and Local Mode

Tuning parameters are mainly effected by load inductance. See following table how to set the parameters according to load inductance. When the dynamic performance is not critical in Local Mode the following parameter table's (Table1) values can be used.

Parameter/L	<1mH	<10mH	<100mH	>100mH
Ramp Limiter *	1-5	5-30	30-120	>120
L-Comp	1023	1023	900-1023	600-900
U-Comp	500	500	500	500
I <sub>fb</sub> Gain	100-300	300-700	700-1023	1023

**Table 1:** Tuning parameters in Local Current mode (BPS-85-70).

Parameter/L	<1mH	<10mH	<100mH	>100mH
Ramp Limiter *	1-5	5-30	30-120	>120
L-Comp	800-900	700-900	600-700	500-700
U-Comp	670	670	670	670
I <sub>fb</sub> Gain	0-30	30-70	70-100	>100

**Table 2:** Tuning parameters in Local Current mode (BPS-40-100).

---

\* Note that Ramp Limiter is not necessarily used. When running sinewave etc. Ramp Limiter should be kept as 0. Ramp Limiter is used when current is desired to ramp to certain current level without overshooting or undershooting at the end of the ramp.

#### 4.4.2 Tuning in Voltage and Local Mode

Ramp Limiter, L-Comp, U-Comp, IfbGain do not effect on V-mode.

UfbGain is the only parameter to change. Keep UfbGain between 0 to 25 for BPS-85-70 and between 0 to 10 for BPS-40-100. Higher values may cause oscillation.



**Note:** Remember to store the parameters after tuning. Parameters will be lost at power down if not stored. **STORE** text in Tuning Menu must be green for permanent store.



## 5 OPERATION: REMOTE MODE

Use dummy plug in PARALLEL connector. INTERLOCK connector should have protective interlocks in use.

In Remote Mode BPS is controlled by CONTROL connector. CONTROL connector's pins are used for:

- Selection of current or voltage mode
- Setting analogue setpoint
- Enabling BPS in Remote Mode
- Reading back output current and voltage values
- Reading Fault signals
- Clearing Faults

Setpoint gains:

Current Mode in single unit:

- $\pm 10V = \pm 70A$  (BPS-85-70).
- $\pm 10V = \pm 100A$  (BPS-40-100).

Parallel mode:

- $\pm 10V = \pm 140A$  (BPS-85-70).

Voltage Mode

- $\pm 10V = \pm 85V$  (BPS-85-70).
- $\pm 10V = \pm 40V$  (BPS-40-100).

See Chapter: Control Interface and **APPENDIX1**: Control interface pin-out



### CAUTION

*In remote mode BPS output is enabled. The output of the BPS will follow the immediately the setpoint signal. When entering to remote make sure to have suitable setpoint present.*

*Input signal (setpoint) connection must not be left unterminated. Input signal's open connection is seen as antenna producing noise to BPS input causing possible oscillation which may damage BPS.*

### 5.1 Computer Control

BPS has an analog Setpoint. If customer needs digital I/O in Setpoint, use separate D/A converter.

### 5.2 Tuning BPS to load in Remote Mode



### CAUTION

*If output voltage is measured with oscilloscope directly from output, oscilloscope must have differential high voltage probe or oscilloscope must be floating. BPS output pins must not be connected to chassis.*



## CAUTION

*If load's energy is too high\*, output current shouldn't be ramped down too fast. If load's energy is transferred too fast to BPS, it would then charge BPS capacitor bank too high and crowbar at output terminal will short circuit the output to protect BPS. Keep the ramp rate slow enough to avoid crowbar operation. Crowbar is reset by powering down BPS. Recovering of crowbar takes about 5 minutes.*



\* **Note:**  $E_{load} > 500J$  in single unit or  $> 1000J$  in parallel connection (BPS-85-70) or  $> 150J$  in single unit (BPS-40-100).



**Note:** BPS can be ordered with Energy Control option (EC). EC will slow down the current slope keeping the energy stored to BPS at safe level, which prevents crowbar triggering/operation.

Remote Mode and Local Mode are using the same tuning parameters. Use the **Table 1** parameters as starting parameters before actual tuning.

Set the suitable pre-selected parameters for different modes and load, see chapter "Tuning BPS to load in Local Mode".

An oscilloscope is needed for monitoring the output current and voltage.

Output current and voltage can be measured from Control connector's pins (see **APPENDIX1:** Control interface pin-out") or by external current and voltage measuring system. BPS's output must not be grounded by normal oscilloscope probe.

Fine Tuning BPS to load is done in remote mode. A signal source (e.g. function generator) is needed in tuning.

### 5.2.1 Tuning in Current and Remote Mode

Tuning can be done with different waveforms:

- a) Square wave setpoint. Using square wave setpoint will make output voltage to hit the rail and there will be overshoot to output current but ramp up time in output current is fast, see Figure 18. Ramp Limiter parameter can be set to slow BPS's internal setpoint's slew rate and the ramp will be slower but without overshoot, see Figure 19.
  - b) Ramp-up with certain slew rate and a plateau after that. Slew rate can be selected so that BPS's output voltage is not clipping (when exceeding voltage limit) during ramp up. Output current can be tuned without having overshoot or undershoot. End result will be the same that square wave with Ramp Limiter, see Figure 19.
  - c) Triangle wave with suitable frequency is good for tuning. See Figure 20.
1. Measure the output current with an oscilloscope. Output voltage measurement is useful for detecting oscillation.
  2. Enable BPS by remote signal and run the waveform.
  3. Go to Tuning Menu by pressing pushbutton1 for 5 seconds.
 

Set parameters by different waveforms:

    - a) Square wave setpoint. Set Ramp Limiter to 0. Decrease the spikes in output voltage with L-Comp and U-comp parameters.
    - b) If Ramp Limiter is used, increase Ramp Limiter value and see how the output is affected. Leave the Ramp Limiter value to point where the output voltage is not clipping and output current has desired settling in plateau. Adjust output current

settling to optimum and minimizing spikes in output voltage by adjusted by L-Comp and U-Comp parameters.

- c) Triangle wave setpoint. Set Ramp Limiter to 0. Adjust output current waveform to optimum and minimize spikes in output voltage by L-Comp and U-Comp parameters. See Figure 20.



**Note:** Tuning images below are done with BPS 85-70.

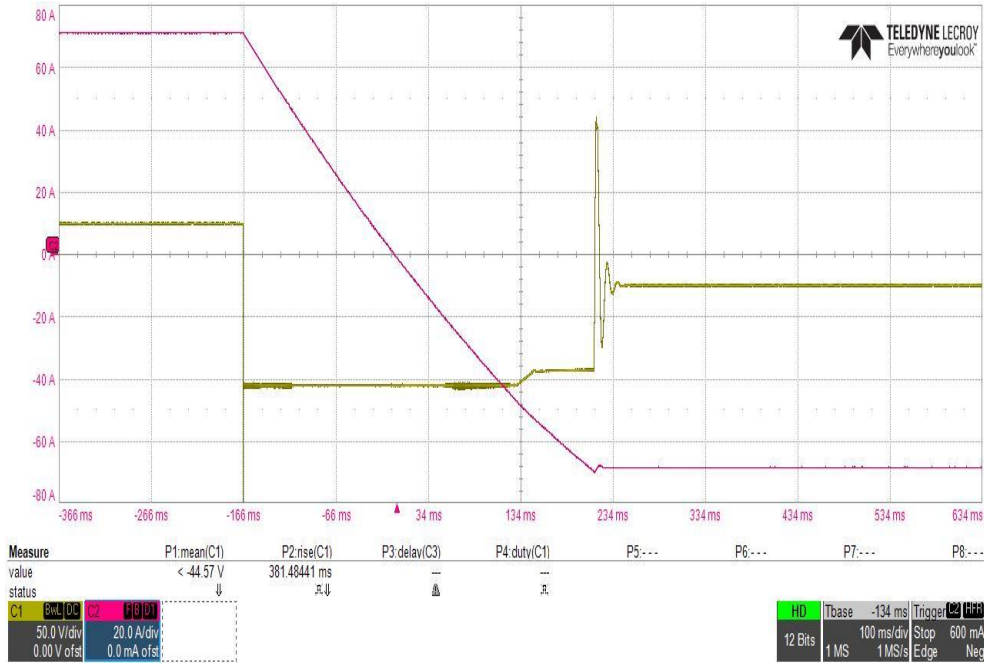

**Figure 18.** Square wave setpoint. Purple track is output current and Yellow track is output voltage.

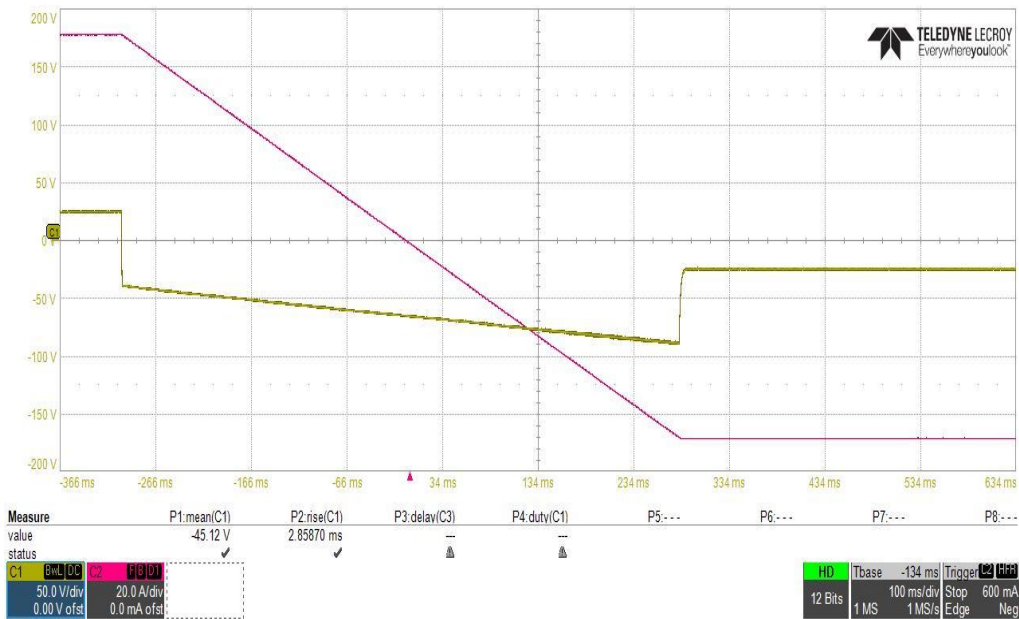

**Figure 19.** Square wave setpoint with Ramp Limiter.

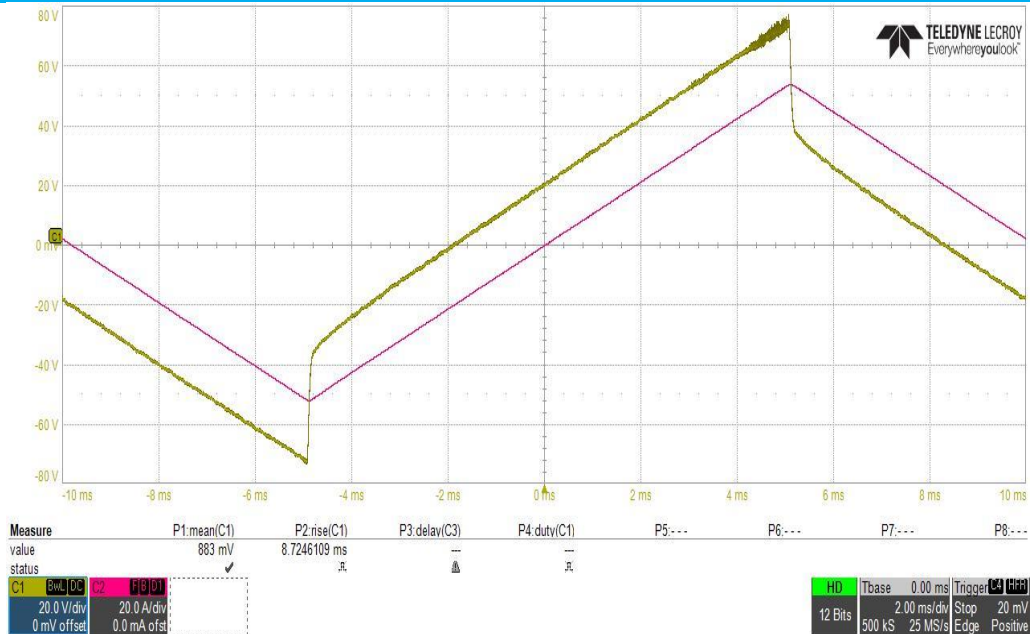

**Figure 20.** Triangle wave in current mode.



**Note:** Remember to store the parameters after tuning. Parameters will be lost at power down if not stored. **STORE** text in Tuning Menu must be green for permanent store.

## 5.2.2 Tuning in Voltage and Remote Mode

Ramp Limiter, L-Comp, U-Comp, IfbGain do not effect on V-mode.

UfbGain is the only parameter to change. Keep UfbGain between 0 to 25 for BPS-85-70 and between 0 to 10 for BPS-40-100. Higher values may cause oscillation.

UfbGain effect can be seen in remote mode e.g. when running square wave. UfbGain effects on voltage spikes at square wave's edges.

## 5.2.3 Tuning in Parallel operation Remote Mode

### 5.2.3.1 Current mode

Tuning is done in similar way than in single unit in Current Mode.

Calibration is needed to verify when changing from single unit to Master unit. Slave unit's tuning parameters are not effecting on operation.

For operation: see Chapter "Parallel Operation"

### 5.2.3.2 Voltage mode

Tuning is done in similar way than in single unit in Voltage Mode.

Calibration of the Master unit is needed to verify when changing from single unit to Master unit. Slave unit's tuning parameters are not effecting on operation.

For operation: see Chapter "Parallel Operation"

## 6 PARALLEL OPERATION



### CAUTION

*Bad configuration may cause wrong amount of output current, oscillation etc.*

*Follow the instructions carefully.*

***BPS-100-40 must not be used as parallel connection.***



Master/Slave Control cable and Master/Slave output cable set is needed for parallel operation connection.

Two BPS-85-70 can be connected in parallel to supply double current.

In parallel configuration BPS's are called Master and Slave. Master unit takes care of control. Slave supplies half of total output current and supplies its current feedback to Master.

### 6.1 Connections

Parallel output cables (red and blue socks) PE cable

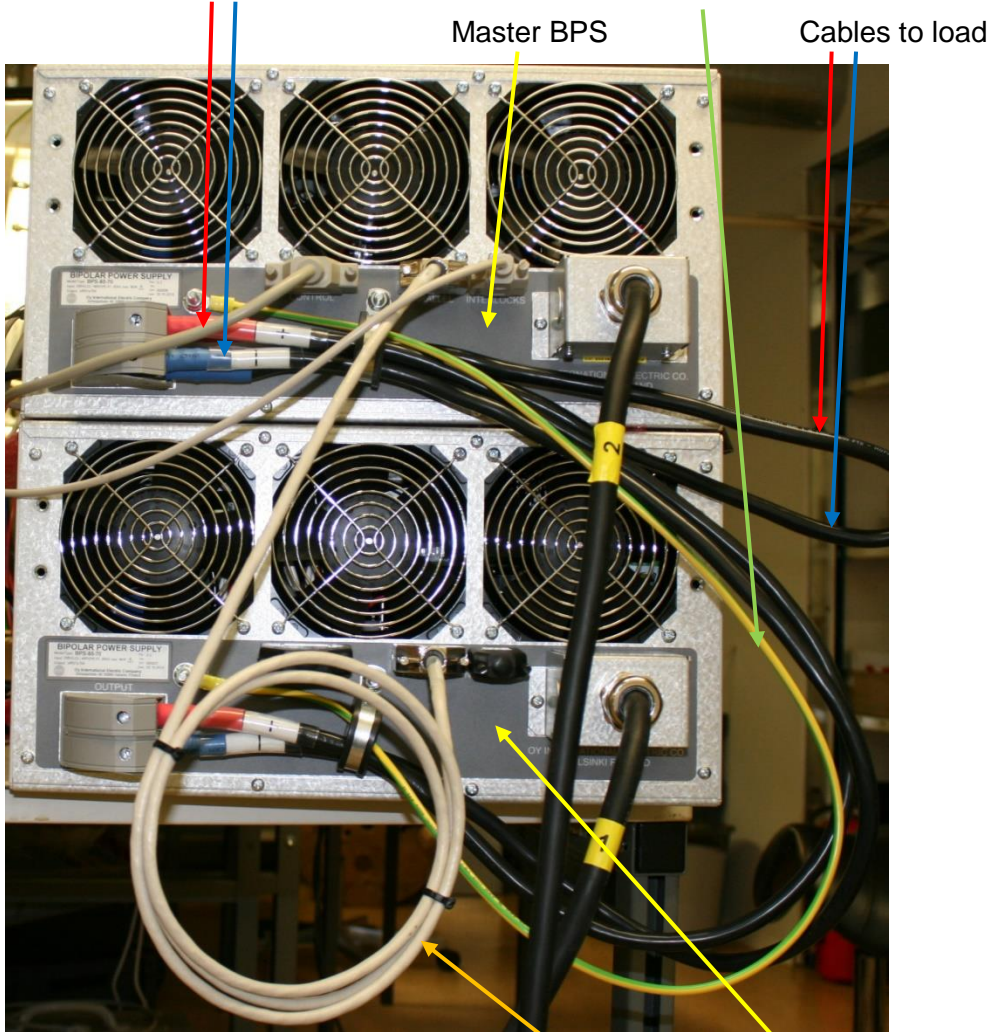

**Figure 21:** Parallel connections Parallel cable Slave BPS

---

### 6.1.1 3-phase Mains voltage connection

3-phase mains is connected to both BPSs.

### 6.1.2 Power output connection

Power outputs of BPSs are connected in parallel:

Connect Master+ to Slave+ and Master- to Slave-. Load should be connected Master BPS's output terminals. Paralleling the outputs shouldn't be done in load's poles.

PE grounds next to output connectors must be connected together.

### 6.1.3 Parallel cable

PARALLEL cable is connected between Master and Slave BPSs' PARALLEL connector. Cable other end has marking MASTER and another SLAVE. Connect the cable according to marking to Master and Slave BPS.

### 6.1.4 CONTROL cable

If used in Remote Mode, CONTROL cable is connected to Master BPS's D25 CONTROL connector. If used in Local Mode, use dummy plug in Master's CONTROL connector. In Slave BPS a dummy plug is used in CONTROL connector.

### 6.1.5 INTERLOCK

INTERLOCK connector should have protective interlock connections in Master BPS. In Slave BPS a dummy plug is used in INTERLOCK connector.

## 6.2 Operation

1. *Make sure that Remote signal is not active. BPS shouldn't be enabled when being configured to Parallel Mode. In Local Mode, do not press enable button before Master-Slave configuration.*
2. *Power up Slave BPS first, wait for 10 seconds and then power up Master BPS. If faults - clear Slave first, then Master. Master faults when Slave faults but Slave doesn't care about Master's fault.*
3. Go to Master BPS's Tuning Menu by pressing Button1 for 5 seconds.
4. Scroll the parameters to ParallelMode by Selector and press Selector. Select ParallelMode=1 → MASTER text is seen at displays top-right corner. Accept and Store parameters.
5. Go to Slave BPS's Tuning Menu by pressing Button1 for 5 seconds.
6. Scroll the parameters to ParallelMode by Selector and press Selector. Select ParallelMode=2 → SLAVE text is seen at displays top-right corner. Accept and Store parameters. Clear the faults.
7. When used in Local Mode, all operations are done via Master BPS's front cover controls. See Chapter "Local Mode".
8. When used in Remote Mode, CONTROL cable is connected to Master BPS only. See Chapter "Remote Mode"
9. Master BPS's display shows total output current and output voltage. Slave BPS's display shows only status.
10. Otherwise Parallel operation is similar to single BPS operation.



**Note:** BPS is factory calibrated as single unit. If a calibrated single unit is configured as Master, it has to be re-calibrated. See, chapter “Calibration”.



**Figure 22:** Parallel operation in use.

## 6.3 Calibration

BPS is factory calibrated. A new calibration can be done in Tuning Menu.

Proper measuring equipment is required: high accuracy current sensor for current mode calibrations and high accuracy voltage meter for voltage mode calibrations.

MENU EXPLANATIONS (calibration parameters only), continued from chapter “Tuning Menu”

IfineGainLocal:	Local Current mode gain calibration
IfineGainRemote:	Remote Current mode gain calibration
IoffsetLocal:	Local Current mode offset calibration
IoffsetRemote:	Remote Current mode offset calibration
UfineGainLocal:	Local Voltage mode gain calibration
UfineGainRemote:	Remote Voltage mode gain calibration
UoffsetLocal:	Local Voltage mode offset calibration
UoffsetRemote:	Remote Voltage mode offset calibration
UmeasOffset:	Voltage measurement offset calibration (mV)

---

UmeasGain:	Voltage measurement gain correction (1%=1000)
ImeasOffset:	Current measurement offset calibration (mA)
ImeasGain:	Current measurement correction (1%=1000)

### 6.3.1 Local Current mode

A high accuracy current measuring system is needed.

1. Run BPS in Local current mode and measure the output current (later Iout) with external measuring system.
2. Enable BPS and set I-SP to 0A. Set Iout to as close to 0A as possible with *IoffsetLocal* parameter.
3. Display should show 0,00A. If not, adjust the display to 0,00A with *ImeasOffset* parameter. Display cannot be seen when adjusting the parameter. 1 digit in *ImeasOffset* parameter equals 1mA. Note that display's last digit is 10mA. **STORE** the parameters.
4. Run the desired test current. Use max available current if the load can withstand it and voltage limit is not limiting the current. Smaller current is also good but preferably >20A.
5. Go to Tuning menu and set Iout to same than test current with *IfineGainLocal* parameter.
6. Display should show the test current. If not, adjust the display to test current with *ImeasGain* parameter. Display cannot be seen when adjusting the parameter. 1 digit in *ImeasGain* parameter equals 0,001% of full value. Note that display's last digit is 10mA. **STORE** the parameters.

### 6.3.2 Remote Current mode

A high accuracy current measuring system is needed.

1. Run BPS in Remote mode and current mode and measure the output current (later Iout) with external measuring system.
2. Set setpoint to 0A and enable BPS by Remote signal. Set Iout to as close to 0A as possible with *IoffsetRemote* parameter.
3. Display should show 0,00A. If not, adjust the display to 0,00A with *ImeasOffset* parameter. Display cannot be seen when adjusting the parameter. 1 digit in *ImeasOffset* parameter equals 1mA. Note that display's last digit is 10mA. **STORE** the parameters.
4. Run the desired test current. Use max available current if the load can withstand it and voltage limit is not limiting the current. Smaller current is also good but preferably >20A.
5. Go to Tuning menu and set Iout to same than test current with *IfineGainRemote* parameter.
6. Display should show the test current. If not, adjust the display to test current with *ImeasGain* parameter. Display cannot be seen when adjusting the parameter. 1 digit in *ImeasGain* parameter equals 0,001% of full value. Note that display's last digit is 10mA. **STORE** the parameters.

### 6.3.3 Local Voltage mode

A high accuracy voltage meter is needed.

1. Run BPS in Local mode and voltage mode and measure the output voltage (later Vout) with voltage meter.
2. Enable BPS and set U-SP to 0V. Set Vout to as close to 0V as possible with *UoffsetLocal* parameter.



3. Display should show 0,00V. If not, adjust the display to 0,00V with *UmeasOffset* parameter. Display cannot be seen when adjusting the parameter. 1 digit in *UmeasOffset* parameter equals 1mV. Note that display's last digit is 10mV. **STORE** the parameters.
4. Run the desired test voltage. Use preferably >20V test voltage if the load can withstand the generated current.
5. Go to Tuning menu and set Vout to same than test voltage with *UfineGainLocal* parameter.
6. Display should show the test voltage. If not, adjust the display to test voltage with *UmeasGain* parameter. Display cannot be seen when adjusting the parameter. 1 digit in *UmeasGain* parameter equals 0,001% of full value. Note that display's last digit is 10mV. **STORE** the parameters.

### 6.3.4 Remote Voltage mode

A high accuracy voltage meter is needed.

1. Run BPS in Remote mode and voltage mode and measure the output voltage (later Vout) with external measuring system.
2. Set setpoint to 0V and enable BPS by Remote signal. Set Vout to as close to 0V as possible with *UoffsetRemote* parameter.
3. Display should show 0,00V. If not, adjust the display to 0,00V with *UmeasOffset* parameter. Display cannot be seen when adjusting the parameter. 1 digit in *UmeasOffset* parameter equals 1mV. Note that display's last digit is 10mV. **STORE** the parameters.
4. Run the desired test voltage. Use preferably >20V test voltage if the load can withstand the generated current.
5. Go to Tuning menu and set Vout to same than test current with *UfineGainRemote* parameter.
6. Display should show the test voltage. If not, adjust the display to test current with *UmeasGain* parameter. Display cannot be seen when adjusting the parameter. 1 digit in *UmeasGain* parameter equals 0,001% of full value. Note that display's last digit is 10mV. **STORE** the parameters.

### 6.3.5 Parallel Mode

BPSs are calibrated as single unit in factory. When running two BPSs in parallel mode, calibration parameters are not necessarily the best ones. Re-calibration is possibly needed. Calibration is done to Master BPS in a similar way than discussed above. Slave BPS is not effecting on calibration.

---

## 7 MAINTENANCE



### WARNING

*Only qualified and properly trained personnel may install or service BPS. Local safety regulations or laws must be followed to ensure the safety of the people working with BPS and that no damage is caused to BPS or any other equipment or property. These instructions are provided only as a reference.*

*Always be sure that the AC power from mains outlet is switched off and the power cord is unplugged before servicing or installing parts to the equipment. There are several large internal capacitors used in the BPS. Always make sure that they are completely discharged before service.*

*BPS has a capacitor bank, which's discharging takes time after power down. When the equipment is operating normally the minimum power down time is 2 minutes. However, in unexpected fault discharging can be longer.*

*There are hot parts inside BPS during and after use. Let BPS cool down by disabling it for 10 minutes before servicing.*

*Do not measure or adjust BPS with the power on unless another qualified person is present.*

*Always keep BPS's top cover closed when BPS is powered. Only qualified service personnel should open the top cover.*

*If the top cover needs to be opened, keep the BPS's 3-phase input cable unplugged for 5 minutes before opening the top cover. This operation is restricted to qualified personnel only and it must be noted that there are hazardous voltages in the units inside BPS. Even if the power is off, capacitors may retain an electrical charge. Guard against risks of electrical shock during open top cover checks by not touching any portion of the electrical circuits. Use safety glasses and hearing protection during open cover checks and troubleshooting to avoid personal injury by any sudden component failure.*

*BPS weighs 55kg (121lb). Never try to lift BPS without help. Always use safety shoes and cut resistant work gloves when lifting or moving BPS.*

*BPS is delivered as stand-alone item and designing possible rack installation is under customer's responsibility. When installing the BPS into a 19 Inch Rack, the customer is responsible for ensuring that the rack is properly secured to prevent inadvertent tipping. The BPS is 55kg (121 lb) and particularly when the BPS is mounted using rack slides it may be possible, if rack installation is not properly designed and secured by the customer, that when the BPS is extended out of the rack e.g. on its slides the rack may become over-balanced and tip.*

*Ensure that electrical and mechanical assemblies and parts of BPS are used with care and inspected regularly (see planned maintenance below).*

## 7.1 Preventive Maintenance

Please contact the sales and service organization of International Electric for the preventive maintenance schedule and content of it.

The only user serviceable part is the dust filter. Dust filter should be checked at regular intervals, not longer than one year.



**Only qualified and properly trained personnel may install or service BPS.  
BPS's top cover should not be opened when the power is on.  
External Mains Switch must be off and power cord unplugged before opening BPS.**

### Dust filter replacement:

1. Remove a long metal cover located at top cover's front end of BPS by three screws. Be careful not to drop the screws into BPS.
2. Pull the dust filter out, see Figure 23.
3. Place a new dust filter to its place
4. Fasten the metal cover back to its place.



**Figure 23:** Dust filter replacement

## 7.2 Troubleshooting



Please carefully examine the cautions listed in beginning of chapter “Maintenance” before doing any of the operations below.

Please read Chapters: “Explanation on controls”, “Display and its menus” and “Operation” for reference.

**Table 3.** Troubleshooting table:

Problem	Possible cause(s)	Actions
Display is off	Circuit Breaker is off.	Turn Circuit Breaker on, see Figure 1.
	BPS powers up for 30 seconds.	Wait for 1 minute.
	AC-power is not present or phase(s) are missing.	Check the AC –supply and connections.
	Internal aux power failure.	Contact service representative.
Fault in Display	Faults present.	Clear faults by pushing reset-button or by remote command. If reset doesn't help go to Fault List (Table 3). Check source of the fault
BPS won't enable Local Mode	Faults present.	Check row: Fault in Display.
BPS won't enable Remote Mode	Remote signal is not present.	Check that Remote input is active at CONTROL connector. See <b>APPENDIX1</b> .
	Faults present.	Check row: Fault in Display.
Current setpoint and current limit can be set too high.	Unit configured as Master but it is used as single.	Check parameter: ParallelMode.
Desired Current or Voltage is not reached	BPS's Current or Voltage limit operates. This can be seen when corresponding limit is red.	Check that current and voltage limits are at desired value.
	Current or Voltage is limited because of load resistance.	Check that load values allow the desired operation.
Poor response	Tuning not optimum.	Check chapter “Tuning BPS to load Local and Remote mode”.
Output Oscillation	Too high lfbGain value in current mode. Too high UfbGain value in voltage mode. Wrong value in other parameters.	Check that tuning parameters are corresponding the load. Check chapter “Tuning BPS to load Local and Remote mode”. Check that Table1 Load/parameter combinations are right.
		Decrease lfbGain/UfbGain value.
Any actions do not help		Contact service representative.



**Note:** One failure may give several secondary faults to display. Check always first the primary fault's actions. *Secondary faults are marked as Italic.*

**Table 4.** Fault list:

<b>Fault in Display</b>	<b>Possible cause(s)</b>	<b>Actions</b>
<b>Interlock0-2</b>	User Interlock is missing or opened.	Check the source of open Interlock. Note: Interlock0 is located in CONTROL connector.
<b>24V</b>	24V aux power supply too low for operation.	Contact service representative.
<b>+16V/-16V</b>	±16V aux power supply is broken.	Contact service representative.
<b>DC #1-3</b> <i>(Possible secondary faults: Vic #1-3 temp)</i>	Internal AC/DC power supply failure.	Contact service representative.
<b>Discharge Overtemp</b> <i>(Secondary faults: DC #1-3, Vic #1-3 temp, Crowbar)</i>	Discharge resistor too hot.	Wait for cooling for 5 minutes. Do not Power down and Power up repeatedly. Reset after cooling down.
	Fault in discharge circuitry	If waiting doesn't help, contact service representative.
Crowbar <i>(no secondary faults)</i>	Overvoltage in internal dc-voltage caused by load's energy. Crowbar protects BPS against internal voltage rise by putting BPS's output connectors to short circuit.	Power down and power up to reset the fault. Wait for 5 minute before powering up.  If load energy > Emax, current rise and fall should be done with slow slew rate to avoid all load's energy flow to BPS too fast. Emax is 500J for single BPS. Emax is 1000J for two BPS in Parallel Mode.
	Powered up too soon after powering down.	Crowbar needs time to open after powering down. Wait for 5 minute before powering up.
	Crowbar damaged.	If crowbar has blown to short circuit, output current will be 0A or BPS can supply only either positive or negative voltage/current.  Contact service representative.
	Note: If Crowbar is damaged, it won't show fault in next power up.	Contact service representative.
<b>Fan Fault</b>	Fan voltage too low.	Contact service representative.
<b>Over Voltage</b> <i>(Secondary fault: DC #1-3, Vic #1-3 temp, Crowbar)</i>	Overvoltage in 3-phase Mains.	Check/Measure 3-phase Mains voltage.
		Check that Voltage Selector Switch is in right position. Power down before turning Voltage Selector Switch to right position.
<b>Under Voltage</b> <i>(Secondary fault: DC #1-3, Vic #1-3 temp, Crowbar)</i>	Undervoltage in 3-phase Mains.	Check/Measure 3-phase Mains voltage.
		Check that Voltage Selector Switch is in right position. Power down before turning Voltage Selector Switch to right position.

<b>Fault in Display</b>	<b>Possible cause(s)</b>	<b>Actions</b>
<b>Uin Partial Loss</b> (Secondary faults: DC #1-3, Vic #1-3 temp, Crowbar, UnderVoltage)	One phase is missing.	Check/Measure 3-phase Mains voltage. Note: Only L3 missing makes the fault. If L1 or L2 is missing, display is off.
	Temporary voltage drop in 3-phase Mains.	Clear fault.
	Internal fuse blown.	If Mains voltage is ok and Uin Partial Loss is still active OR display is off → Contact service representative.
<b>Vic #1-3 temp ONLY</b> (No secondary faults) Note: Vic #1-3 temp is secondary fault for many primary faults.	Overtemp in VIC card.	Check that BPS fans are rotating.
		Check that environment temperature is <40°C.
		Make sure that no obstacles are disturbing air inlet or outlet of BPS.
		Let the unit cool down for 5-10 minutes and reset.
	Nothing helps → VIC-Unit needs to be replaced. Contact service representative.	
<b>Vic #1-3 Drivefail</b>	Control error in VIC card.	VIC-Unit needs to be replaced. Contact service representative.
<b>Vic #1-3 Fuse</b>	Internal DC-bus voltage missing.	See row DC #1-3.
	Fuse blown in VIC card.	VIC-Unit needs to be replaced. Contact service representative.
<b>Vic #1-3 Uaux</b>	Aux power error in VIC card.	VIC unit needs to be replaced. Contact service representative.
<b>Parallel Fault and Parallel Connection</b>  Many common faults with same actions	In single BPS mode: dummy connector missing from Parallel connector.	Put dummy connector to Parallel connector. Check that unit is configured as single unit.
	Bad configuration.	Ensure that Master BPS is configured as Master and Slave BPS as Slave.
	In Parallel mode: Slave BPS has Fault.	Check Slave BPS Faults.
	In Parallel mode: Parallel cable is disconnected.	Check Parallel cable.
	Parallel unit is powered down.	Power up Parallel unit.
<b>IsenseFail</b>	Current sensor failure.	Power down and power up BPS.
<b>EEPROM Write</b>	Storing parameter failed.	STORE parameters again. Reset BPS.
<b>EEPROM Read</b>	Parameters reading during power up failed.	Power down and power up BPS.

**Table 3.** Fault list



Note: Always make sure that all cables are connected correctly after service e.g. by suitable test of the BPS.

## 8 SPECIFICATIONS

Specifications are valid both BPS-85-70 and BPS-40-100 Units unless otherwise noted. The differences in *BPS-40-100* are written in *Italic*.

### 8.1 Features

High performance bipolar power supply with  $\pm 85$  V,  $\pm 70$  A output

*BPS-40-100:  $\pm 40$ V,  $\pm 100$ A*

Parallel operation in current mode for  $\pm 85$  V and  $\pm 140$  A

*BPS-40-100: no parallel operation*

4-quadrant output operation

Operation with wide range of loads

Voltage mode and current mode

Very low ripple and noise

Flux gate current transducer for excellent temperature and long term current stability

Ramp response for different loads tuned from front panel

Analogue voltage programming of output voltage or current

Air cooled, 19 " rack mountable package (5 U), 55 kg (121 lb)

Crowbar at output to protect BPS from high energy loads.

Energy Control (EC, optional). In case of high energy load, EC slows down the current ramp avoiding crowbar to operate

### 8.2 Output performance

Output voltage max	$\pm 85$ V. <i>BPS-40-100: <math>\pm 40</math>V</i>
Output current max	$\pm 70$ A. <i>BPS-40-100: <math>\pm 100</math>A</i>
Output power	6 kW. <i>BPS-40-100: 4kW</i>
Small signal bandwidth	> 10 kHz (-3dB)
Switching frequency	250 kHz

#### 8.2.1 Voltage mode:

Line regulation	< 0.01 % (supply voltage min-max)
Load regulation	< 0.05 % (output current 0 – max)
Gain accuracy	< 0.02 %
Gain drift vs. time	< 0.01 % (any 8 hour period after 10 min warm up time)
Gain drift vs. temperature	< 0.005 % / $^{\circ}$ C (10 ... 40 $^{\circ}$ C)
Initial offset	< 5 mV (adjustable to 0 mV)
Offset drift vs. time	< 5 mV (any 8 hour period after 10 min warm up time)
Offset drift vs. temperature	< 1 mV / $^{\circ}$ C
Output noise voltage	< 0.2Vrms (0.1Hz...200kHz)
Switching ripple voltage	< 1 Vrms differential (>250kHz)

## 8.2.2 Current Mode:

Line regulation	< 0.01 % (supply voltage min – max)
Load regulation	< 0.05 % (output voltage 0 – max)
Gain accuracy	< 0.02 %
Gain drift vs. time	< 0.01 % (any 8 hour period after 10 min warm up time)
Gain drift vs. temperature	< 0.005 % /°C (10 ... 40°C)
Initial offset	< 5 mA (adjustable to 0 mA)
Offset drift vs. time	< 5 mA (any 8 hour period after 10 min warm up time)
Offset drift vs. temperature	< 1 mA /°C
Output noise current	< 1 mArms (0.1Hz...10kHz)
Switching ripple voltage	< 1 Vrms differential (>250kHz)
	<i>BPS-40-100: &lt; 500 mVrms differential (&gt;250kHz)</i>

## 8.3 Control and monitoring

### Local Mode, programming via front panel:

Voltage mode	-85V to +85V.
	<i>BPS-40-100: -40V to +40V</i>
	Setting resolution 10mV.
Current mode	-70A to +70A.
	<i>BPS-40-100: -100A to +100A</i>
	Setting resolution 10mA

### Remote Mode:

Programming, voltage mode	1V/8.5V ( $\pm 10$ V for $\pm 85$ V) Differential
	<i>BPS-40-10: 1V/4V (<math>\pm 10</math> V for <math>\pm 40</math> V) Differential</i>
Programming, current mode	1V/7A ( $\pm 10$ V for $\pm 70$ A) Differential
	<i>BPS-40-10: 1V/10V (<math>\pm 10</math> V for <math>\pm 100</math> V) Differential</i>
Signal input impedance	40 k $\Omega$
<b>Fault protection:</b>	Internal overtemperature
(Output shutdown due to)	AC input voltage out of tolerance
	Internal voltages out of tolerance
	Output crowbar protection for excess returned load energy
	Two external interlocks
Display	TFT 4.3" color display with large view angle
Local mode	Voltage or current mode selected via display
	Voltage or current output set by knob
	Enable button for activating the output
Remote mode	Remote mode connector on rear panel
	Remote mode enabled by logic signal
	Voltage or current mode selected by logic signal



	Voltage or current output set by analog programming signal
Tuning	Response for different loads can be fine-tuned at display
Voltage limit	Absolute max voltage limit set via display
Current limit	Absolute max current limit set via display

## 8.4 System specifications

Input voltage requirements	208V: 187-264VAC 47-63Hz 3-phase Delta, or 400V: 3 x 187-264VAC 47-63Hz L1, L2, L3, N Selected by switch at rear panel
Input current	typ. 20A/187VAC 16A/230VAC <i>BPS-40-100: typ. 15A/187VAC 16A/230VAC</i>
Power factor	typ. 0.95/230VAC at full load
Efficiency	0.75 at 6kW output power <i>BPS-40-100: 0.65 at 4kW output power</i>
Inrush current	typ. 60A@230VAC at cold start
Leakage current	< 2mA/240 VAC

## 8.5 Environmental requirements:

Ambient temperature	10 °C to 40 °C
Ambient humidity	30 to 70 % non-condensing
Storage temperature	-20 °C to +85 °C
Cooling	Forced air cooling (front in, rear out) Removable, washable dust filter with capability to replace

### Unit dimensions:

Mounting	19" rack. Provision for rack slides
Height	221,5 mm (5U, 8.75")
Width	483 mm (19")
Depth	740 mm (29.1")
Weight	55 kg (121 lb)

## 8.6 Regulatory

Designed to meet	EN 61010, UL 61010 AC/DC section: UL60950-1, TUV 60950-1 approved CE marked
------------------	---

## APPENDIX1: Control interface pin-out

### CONTROL

Sub D-25 male. Pin-out:

Pin	Name	Function	Note
1	+Sp	Setpoint + <b>2)</b>	I Mode: $\pm 10V = \pm$ nominal current <b>1)</b> V Mode: $\pm 10V = \pm$ nominal voltage
2	-Sp	Setpoint - <b>2)</b>	return
3			
4	+Imon	Current monitor +	$\pm 10V = \pm$ nominal current <b>1)</b>
5	-Imon	Current monitor -	return
6			
7	Overheat COM		
8	Overheat contact	Fault or Powered Down: open contact No Fault: closed contact	Normally energized = closed contact
9	Interlock Out COM		
10	Interlock Out contact	Fault or Powered Down: open contact No Fault: closed contact	Normally energized = closed contact
11	Remote	Remote input	Connection to +24V
12	+24V	Auxiliary power	
13	V-mode	Voltage mode selector	Connection to +24V
14			
15			
16			
17	+Vmon	Voltage monitor +	$\pm 10V = \pm$ nominal voltage
18	-Vmon	Voltage monitor -	return
19			
20			
21	Fault contact	Fault or Powered Down: open contact No Fault: closed contact	Normally energized = closed contact
22	Fault COM		
23	Interlock0	Fault: open contact No Fault: closed contact	Connection to +24V
24	+24V	Auxiliary power	
25	Reset	Reset faults	Connection to +24V min. 100ms pulse

**1)**  $\pm 10V = \pm$  double of nominal current in Parallel Mode.

**2)** Maximum voltage  $\pm 12V$  to chassis.



Note: Always make sure that Setpoint signals' polarity is correct, e.g. by suitable test of the BPS.

## Schematic representations of Control connector.

All drawings are cable connectors, seen from front side of the connector (female). BPS has male connector.



### CAUTION

Maximum voltage of each Setpoint pin is  $\pm 12V$  to chassis. Otherwise permanent damage may occur.

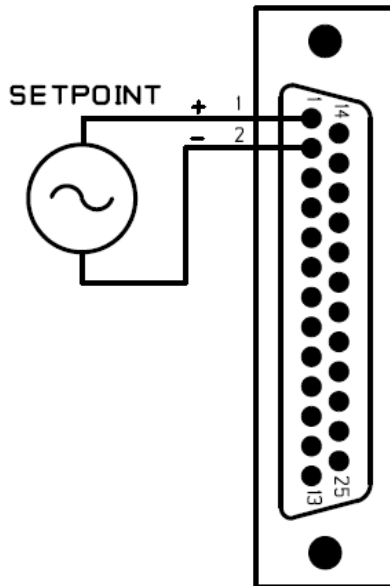

Figure 24: External wiring for Setpoint.

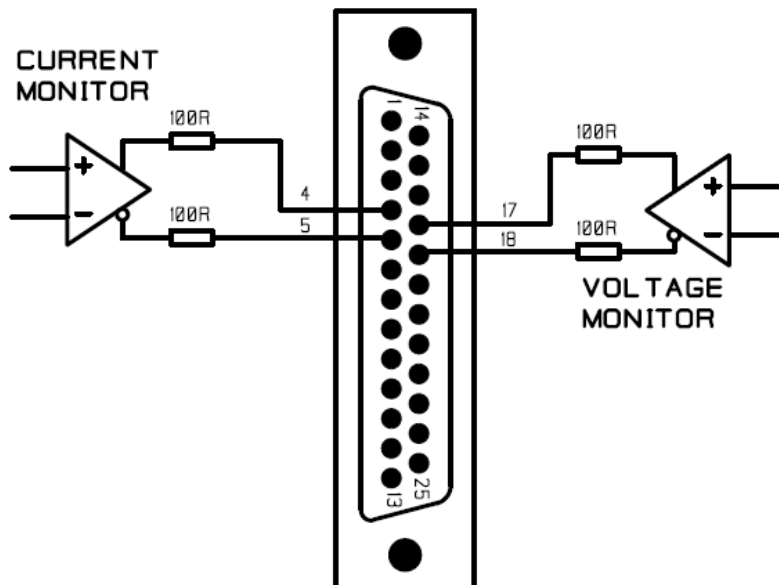

Figure 25: Internal wiring of Current and Voltage monitors. Differential output.

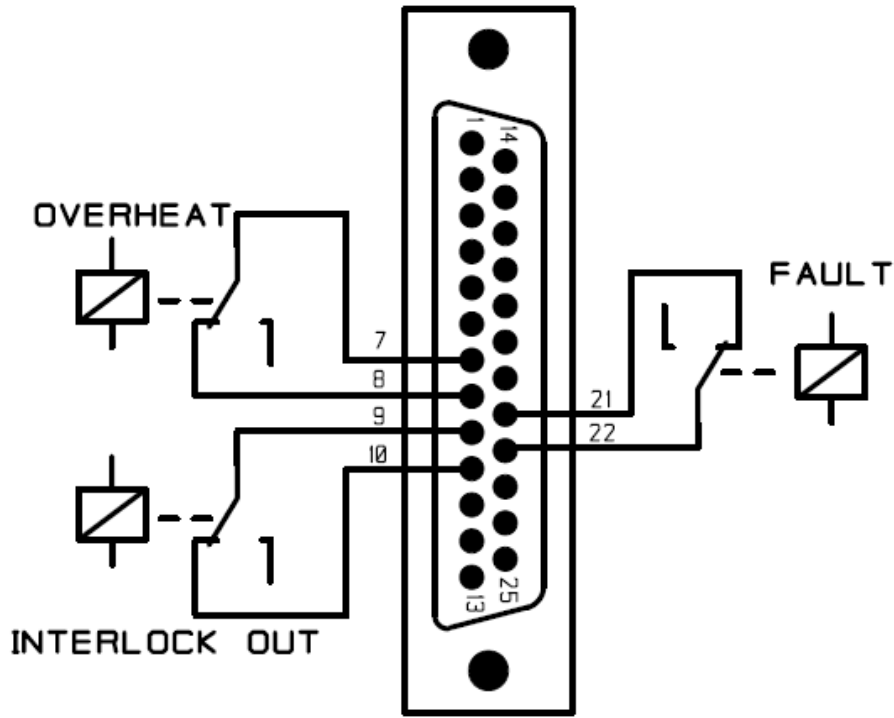

Figure 26: Internal wiring of relay outputs (drawn energized and normal operating state).

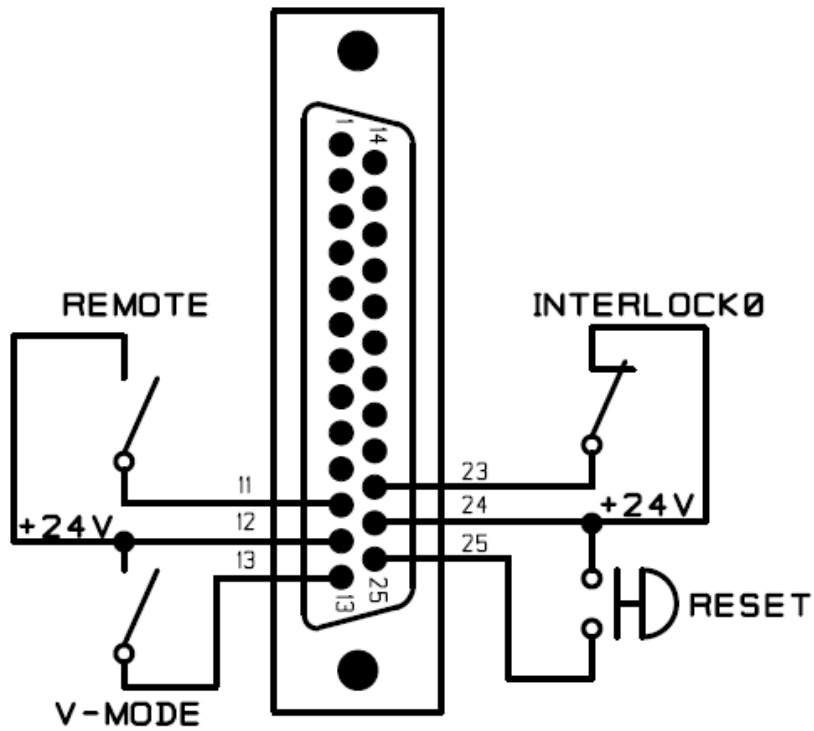

Figure 27: External wiring for Controls.



Note: +24V is internal auxiliary voltage generated by BPS.

If optocouplers are used, note the polarity. Sink current capability > 12mA.

**Interlocks**

Sub D-9 female.

Pin-out:

Pin	Name	Description	Note
1	+24V	+24V for Interlock1	
2			
3			
4			
5	Interlock2	Fault: open contact No Fault: closed contact	
6	+24V	+24V for Interlock2	
7			
8			
9	Interlock1	Fault: open contact No Fault: closed contact	

**Schematic representation of Interlocks connector.**

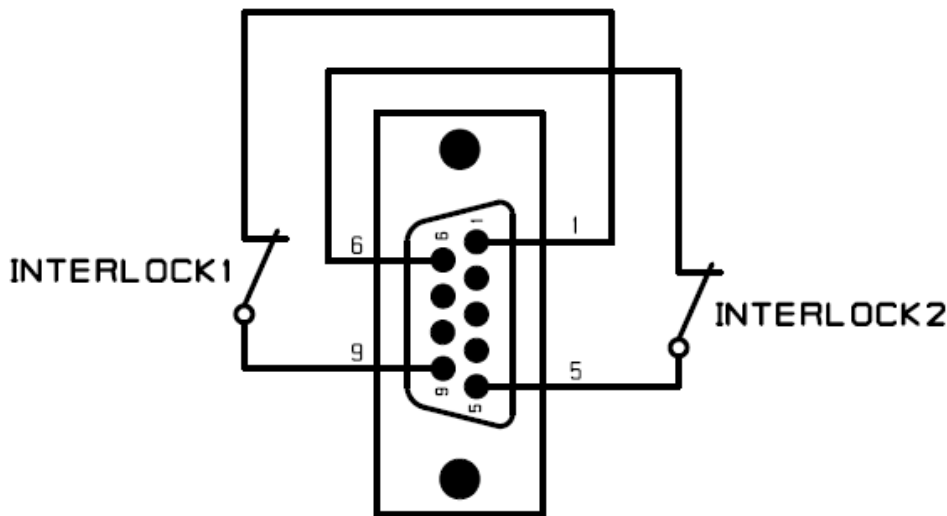

**Figure 28:** External wiring of interlock connections. Switches are potential free contacts.

Drawing is cable connector, seen from front side of the connector (male). BPS has female connector.



Note: If EMO is used, connect it to interlock as normally closed.

**Parallel**

Sub D-15 female.

Pin-out:

Pin	Name	Description	Note
1	Isense +		
2	Ctrl-Out -		
3	Ctrl-In +		
4	Master_Ok		
5	Slave_Ok		
6	Enable_In		
7	#ParallelFailed	Fail Safe	
8	GND_in		
9	Isense -		
10	Ctrl_Out +		
11	-Ctrl_In		
12	+24V		
13	Enable_Out		
14	#Fault_Out	Fail Safe	
15	GND_OUT		



Note: IEKO provides cable for Parallel connector between Master BPS and Slave BPS. Customer doesn't need to make any cable for Parallel connection.

---

## 9 WARRANTY AND LIABILITY

1. Under warranty, Oy International Electric Company (“Seller”) will replace or repair the defective Parts free of charge. Defective Parts shall be delivered to Seller to be serviced at Seller’s premises (DDP HELSINKI).
2. The warranty period is twelve (12) months from the date of delivery. The Purchaser will, at its expense, return the defective Product or parts thereof to the Seller in accordance with the return procedure specified by the Seller. The Seller will, at its expense, deliver the repaired or replaced Product or parts to the Purchaser. Any warranty of the Seller will not apply if the Purchaser is in default under the Purchase Order Agreement or where the Product or any part thereof:
  - is damaged by misuse, accident, negligence or failure to maintain the same as specified or required by the Seller;
  - is damaged by modifications, alterations or attachments thereto which are not authorized by the Seller;
  - is installed or operated contrary to the instructions of the Seller;
  - is opened, modified or disassembled in any way without Seller’s consent; orThe Purchaser may not assert any claim that the Products are not in conformity with any warranty until the Purchaser has made all payments to the Seller provided for in the Purchase Order Agreement.
3. INTERNATIONAL ELECTRIC COMPANY OY MAKES NO WARRANTY AS TO THE ACCURACY, SUFFICIENCY OR SUITABILITY OF ANY TECHNICAL OR OTHER INFORMATION PROVIDED IN ITS MANUALS OR OTHER DOCUMENTATION. The use of such information will be entirely at the user’s risk.
4. Unless specifically agreed in writing between the Purchaser and the Seller, the Seller shall be under no liability to the Purchaser or any third party under these conditions, any Contract or otherwise for any loss or damage howsoever caused to the Buyer or any other person including, without limitation, any loss of profit, loss of earnings, damage to property, business interruption, damage to reputation or goodwill or any indirect, special or consequential loss or damage and any term, condition or representation to the contrary whether express or implied by statute, common law or otherwise is hereby expressly excluded as far as it is possible to exclude it, save for fraudulent misrepresentation to which this exclusion shall not apply.
5. The liability of the Seller to the Purchaser or any third party for any loss or damage of whatsoever nature and however caused shall be limited to and in no circumstances shall exceed the price paid by the Purchaser for the Products.
6. The Products delivered by the Seller have been designed for various applications; their suitability for a particular application lies in the responsibility of each customer. The Products are not authorized for use in safety-critical applications without Seller’s explicit written consent. A safety-critical application is an application where a failure may reasonably be expected to endanger or cause loss of life, inflict bodily harm or damage property. The applicant shall indemnify and hold harmless Seller, its affiliated companies and its representatives against any damage claims in connection with the unauthorized use of Seller’s Products in such safety-critical applications.

---

## Company in brief

Oy International Electric Company (IECO) designs and manufactures state-of-the-art electronics for medical, industrial and military applications tailored to meet customer needs.

With 40 years of experience in power electronics we are able to provide solutions for even the most challenging requirements. IECO's quality system is ISO 9001 and ISO 13485 certified.

## Power amplifier technology

IECO introduced its first gradient amplifier in 1994. This revolutionary PWM amplifier enabled excellent image quality in open MRI systems. Simultaneously IECO also launched the first D-class magnet power supply delivering new efficiency levels with 0,1ppm accuracy. IECO's expertise has recently been utilized in the development of the industry's first High Temperature Superconductive MRI magnets.

IECO's power amplifiers are easily scalable for any type of load and any power level needed. Compact amplifier units can be connected in series or in parallel in Master/Slave operation to gain output voltages up to 1100V and output currents up to 1200A. Thanks to low-noise, wide bandwidth and excellent step response, IECO has gained the reputation of a technology leader in gradient amplifiers.

Over 1000 amplifier and magnet power supply systems delivered worldwide.



### **Oy International Electric Company**

Sahaajankatu 48  
00880 Helsinki  
Finland

Email: [info@ieco.fi](mailto:info@ieco.fi)  
Internet: [www.ieco.fi](http://www.ieco.fi)